

Spare parts Price List for the Zebra P310 series Printers

Print Engine and P310 Feeder

Non-ROHS Printers

Prices in USD



Print Engine Rear View	3
Feeder Module	41
Power Supply	56
Print Engine Front View	59
Belts	63
Print Engine Top View	67
Print Head	96
Rear Panel View	101
Covers	110

**Print Engine Module
(Rear View)**

P310C/I based Printers

PRINT ENGINE REAR VIEW

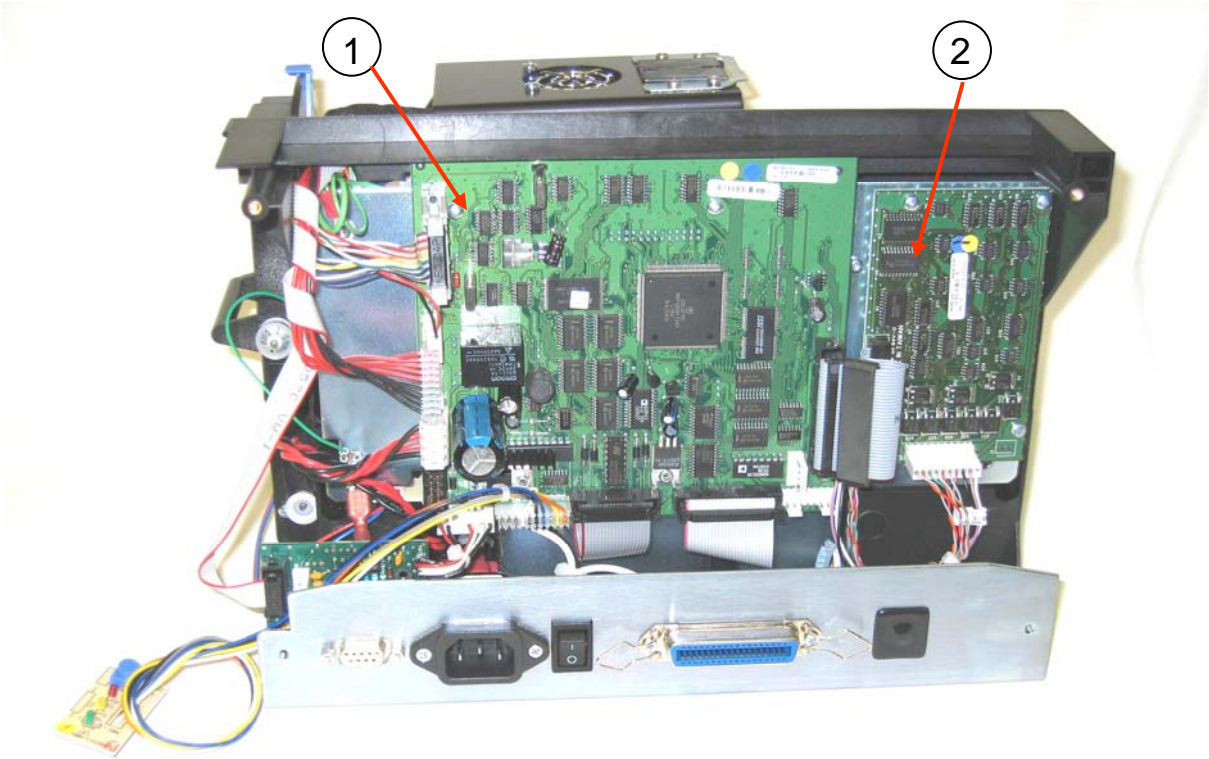

Item #	Kit Number	Description	Price
1	105912-026	PCBA Cold Fire Tested CPU (P310C only)	600.00
1	105912-060	PCBA Cold Fire Tested CPU (P310F only)	600.00
1	105912-607	PCBA Cold Fire Tested CPU (P310i only)	600.00
2	105912-025	PCBA Magnetic Card Writer	230.00

PRINT ENGINE REAR VIEW

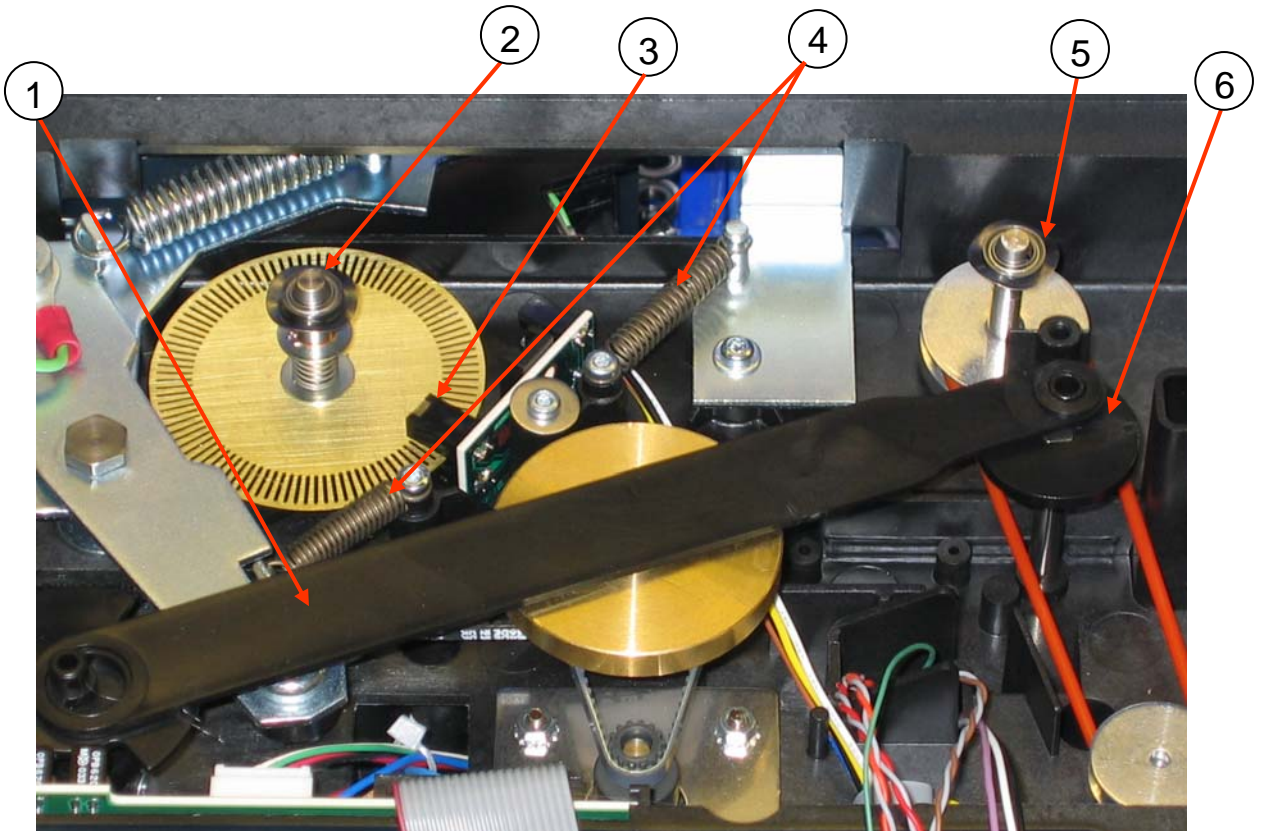

Item #	Kit Number	Description	Price
1	105912-538	Cam Follower Arm (set of 5)	27.00
2	105912-200	Washer Wavy 400 x 575 (set of 20)	24.00
3A	105912-067	PCBA Film & Bracket Sensor I serie	32.00
3	105912-016	PCBA Film & Bracket Sensor c serie	58.00
4	105912-535	Spring, Head Release (set of 10)	26.00
5	105912-180	Bearing, Ball, Flanged (set of 17)	76.00
6	105912-551	Upper Cam, Print Engine (set of 5)	27.00

PRINT ENGINE REAR VIEW

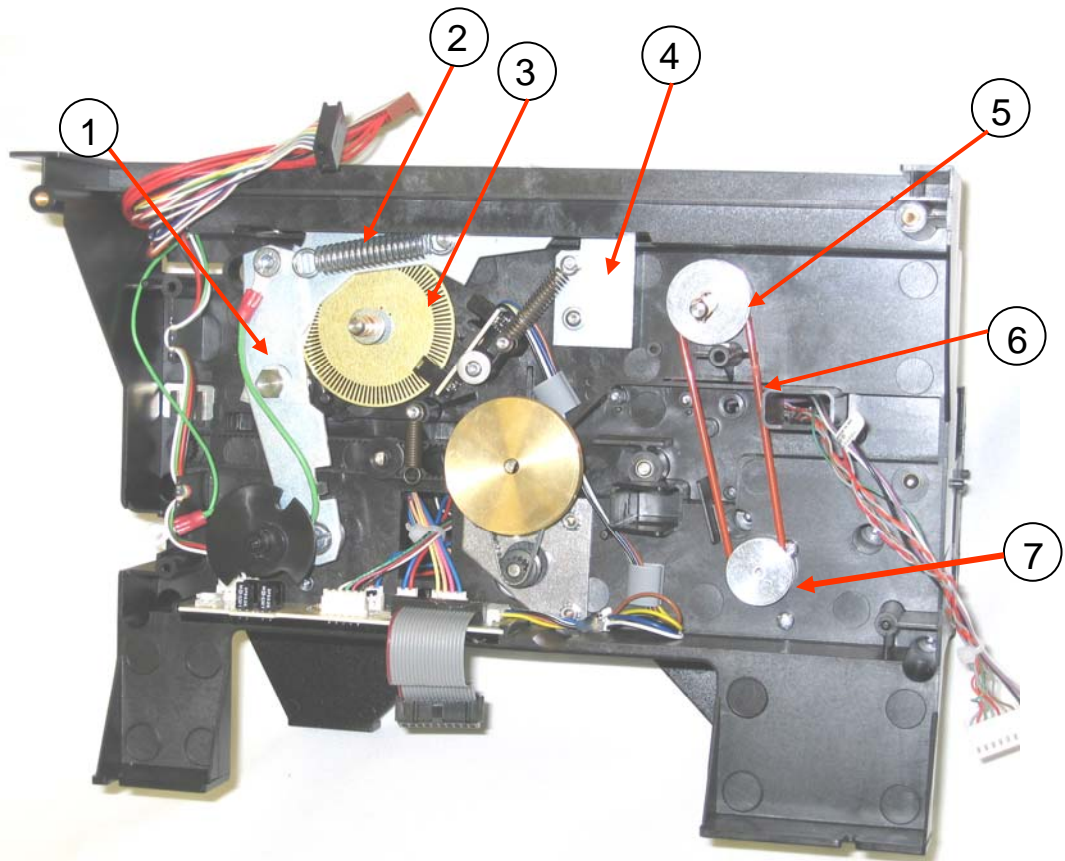

P310C & P310i

Item #	Kit Number	Description	Price
1	105912-533	Printhead Kit, Cam assembly	40.00
2	105912-079	Printhead Pressure Spring (Set of 10)	27.00
3	105912-050	Kit, Flag Clutch Assembly C series	65.00
3A	105912-629	Kit, Flag Clutch Assembly I series	39.00
4	105912-536	PrintHead Release Lever (set of 5)	23.00
5	105912-017	Ribbon Take up Pulley & Shaft (upper)	57.00
6	105909-038	Ribbon Take Up O-Ring Kit (set of 5)	37.00
7	105912-537	Ribbon Take up Pulley Lower (set of 5)	30.00

PRINT ENGINE REAR VIEW

P310C & P310i

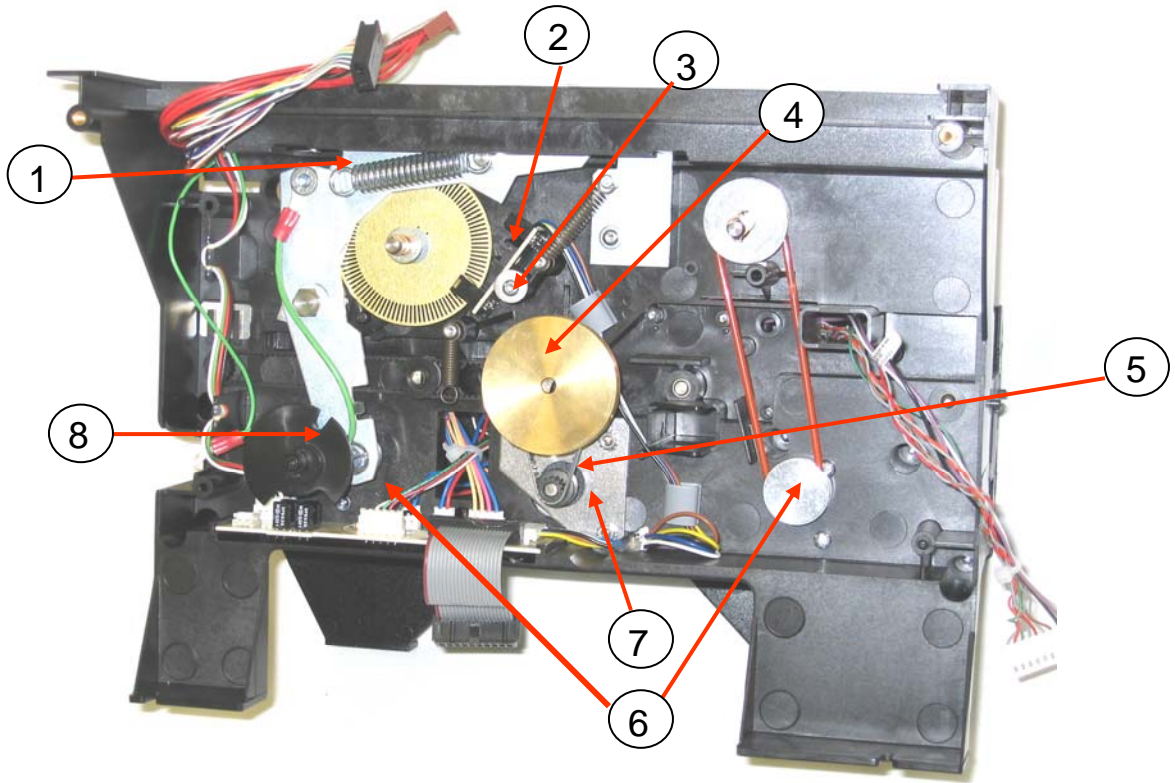

Item #	Kit Number	Description	Price
1	105912-543	Kit, Head Load Lever P310	29.00
2	105912-016	PCBA Film & Bracket Sensor c series	58.00
2A	105912-067	PCBA Film & Bracket Sensor I series	58.00
3	105912-544	Sensor Retaining Fastener (Obsolete)	23.00
4	105912-545	Inertia Roller/set screw	27.00
5	105909-040	Stepper Motor Drive Belt Kit (set of 5)	58.00
6	105912-006	Cable Assembly D.C. Motor Low Torque	85.00
7	105909-103	Stepper Motor & Cable Assembly	209.00
8	105912-546	Head Up/Dwn Cam/W Screw (Set of 5)	27.00

PRINT ENGINE REAR VIEW

P310C & P310i



P320i/P420i/P520i

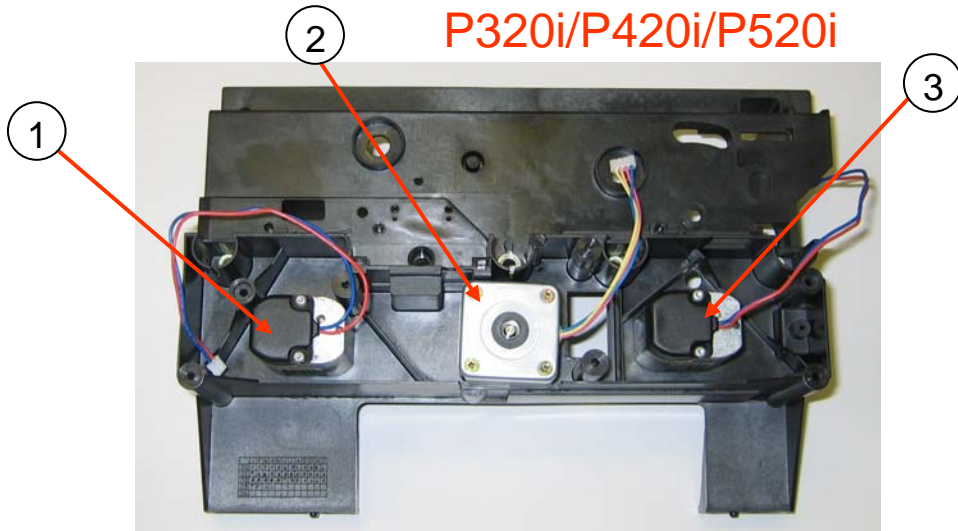

Item #	Kit Number	Description	Price
1	105912-006	Motor, D.C. & Cable low torque	85.00
2	105909-103	Motor, Stepper & Cable	209.00
3	105912-787	Motor, D.C. & Cable high torque	85.00

PRINT ENGINE REAR VIEW

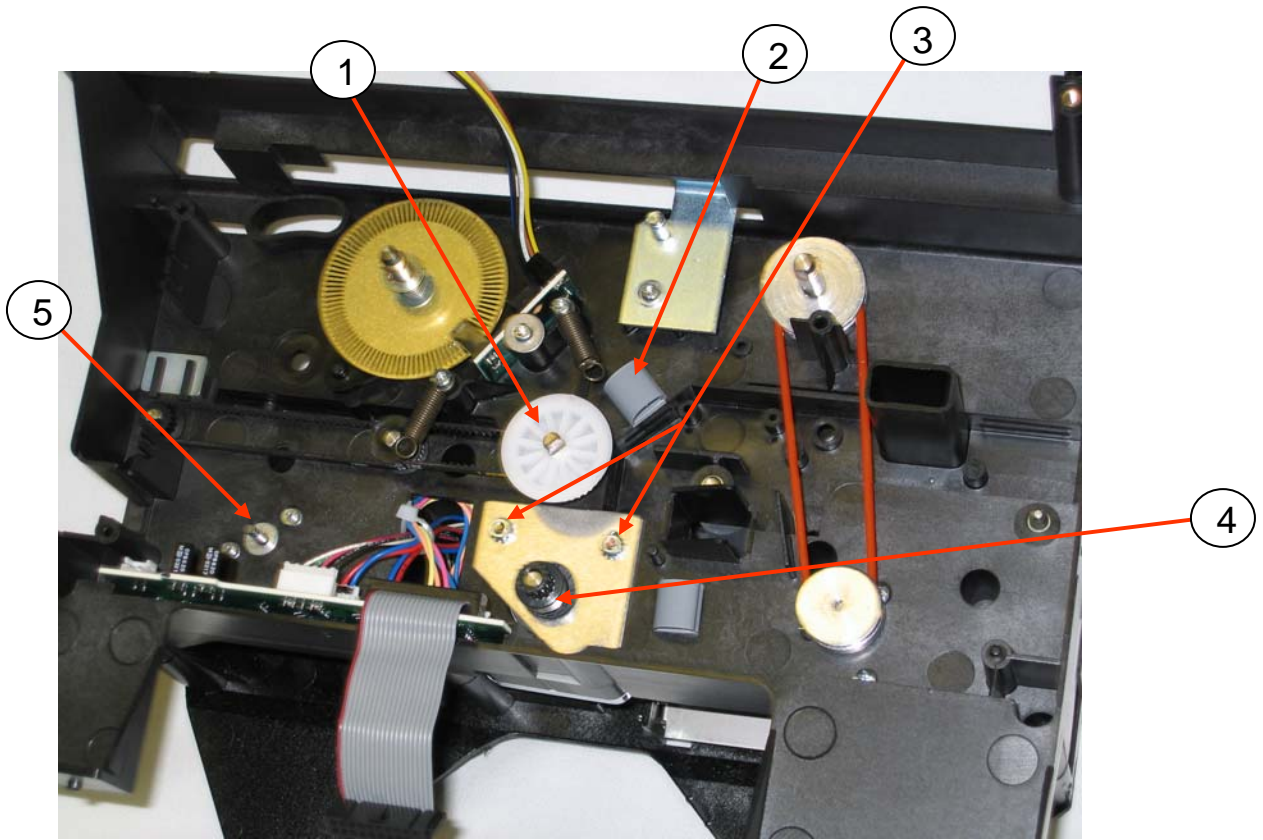

Item #	Kit Number	Description	Price
1	105912-547	Pulley, 42T P310 (set of 5)	31.00
2	105912-548	Plastic Cable Clip	29.00
3	105912-550	KEPS Nut /Washer (Obsolete)	20.00
4	105909-103	Motor, Stepper and Cable	209.00
5	105912-006	DC Motor and Cable low torque	85.00
5A	105912-787	DC Motor and Cable high torque	85.00

105912-787 for P320i,P420i and P520i

PRINT ENGINE REAR VIEW

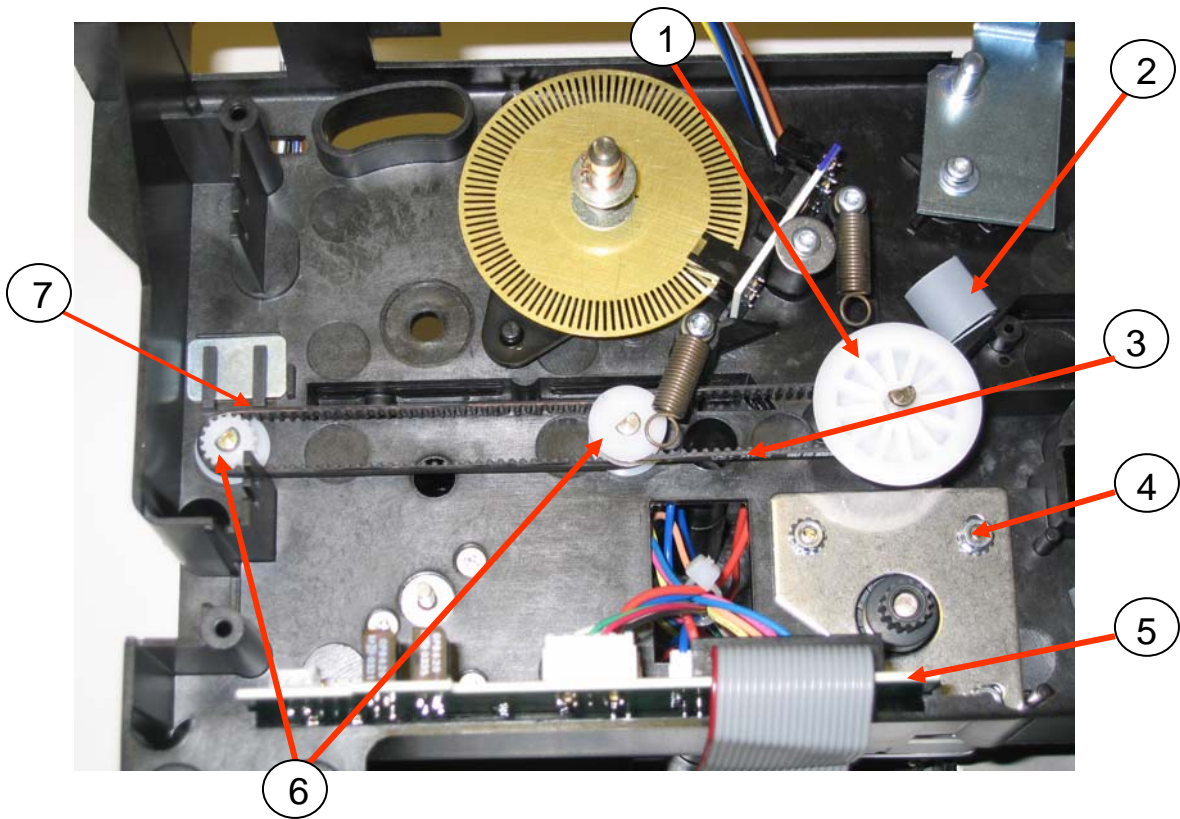

Item #	Kit Number	Description	Price
1	105912-547	Pulley 42T P310 (set of 5)	31.00
2	105912-548	Plastic Cable Clip	29.00
3	105912-018	Timing Belt, 65Tx1/8 2MR-130 (set of 5)	30.00
4	105912-550	KEPS Nut Washer Attached (Obsolete)	20.00
5	105912-020	PCBA Daughter,	80.00
6	105912-549	Pulley, White, 17T 5mm ID (Set of 10)	23.00
7	105912-019	Timing Belt, 90Tx1/8 2MR-180 (set of 5)	32.00

PRINT ENGINE REAR VIEW

Print Engine's Belts for Printers based on the P310 Print Engine

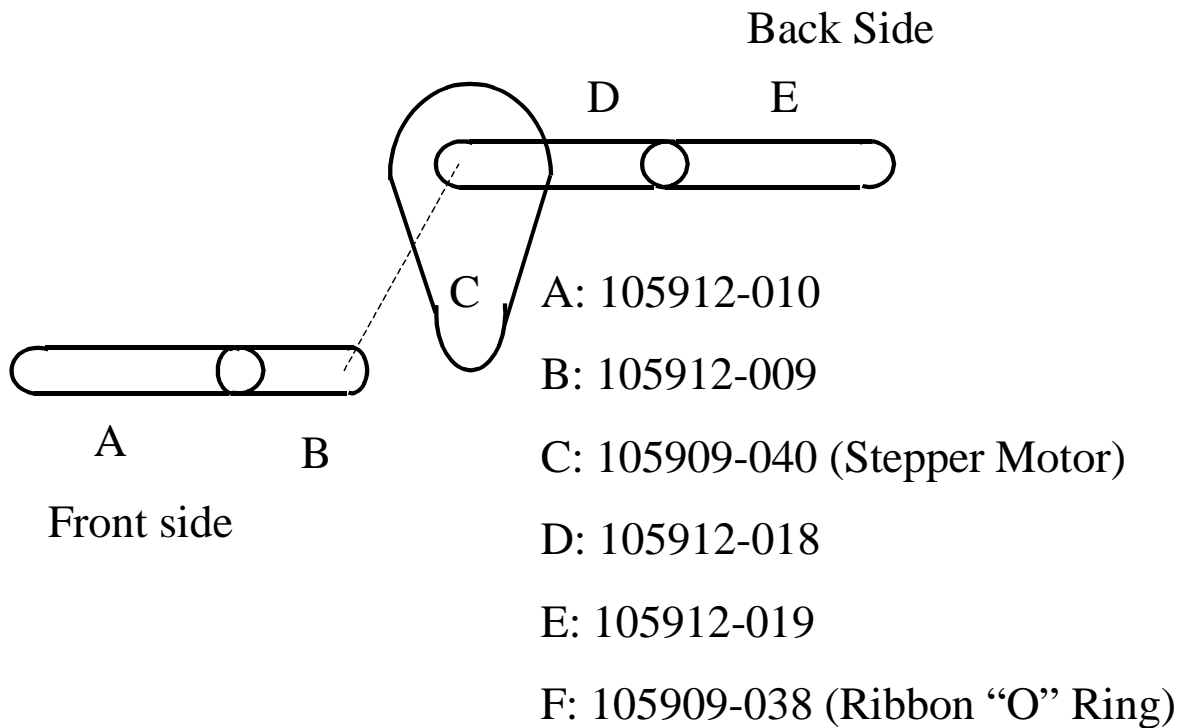

PRINT ENGINE REAR VIEW

P310 C series

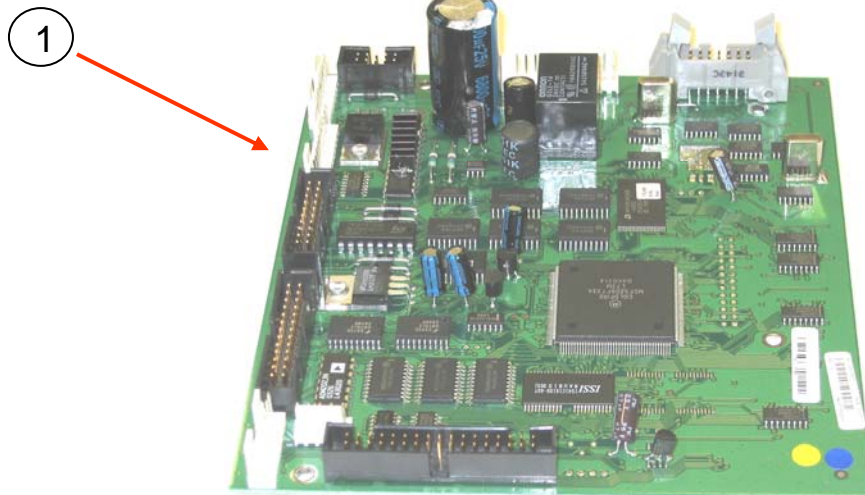

Item #	Kit Number	Description	Price
1	105912-026	PCBA Cold Fire Tested CPU (P310C Only)	600.00
1A	105912-060	PCBA Cold Fire Tested CPU (P310F Only)	600.00

PRINT ENGINE REAR VIEW

P310i

1



2

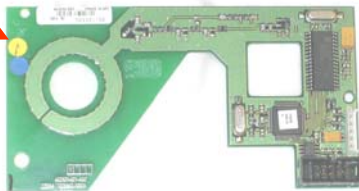

Item #	Kit Number	Description	Price
1	105912-607	PCBA Cold Fire Tested CPU (P310i Only)	600.00
2	105912-628	PCBA RFID Reader	111.00

PRINT ENGINE REAR VIEW

P420C/P520c/P720c

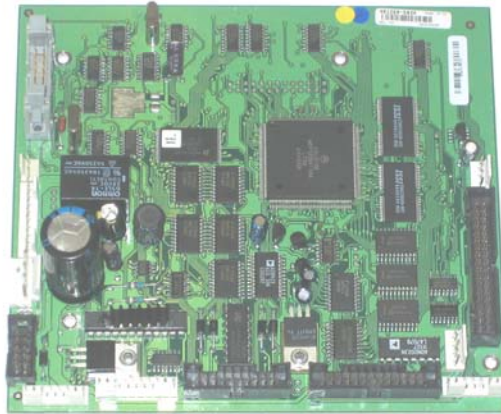

Kit Number	Description	Price
105912-081	PCBA Cold Fire Tested CPU P420c/P520c	600.00
105912-108	PCBA Cold Fire Tested CPU P720	600.00

PRINT ENGINE REAR VIEW

P320i/P420i/P520i

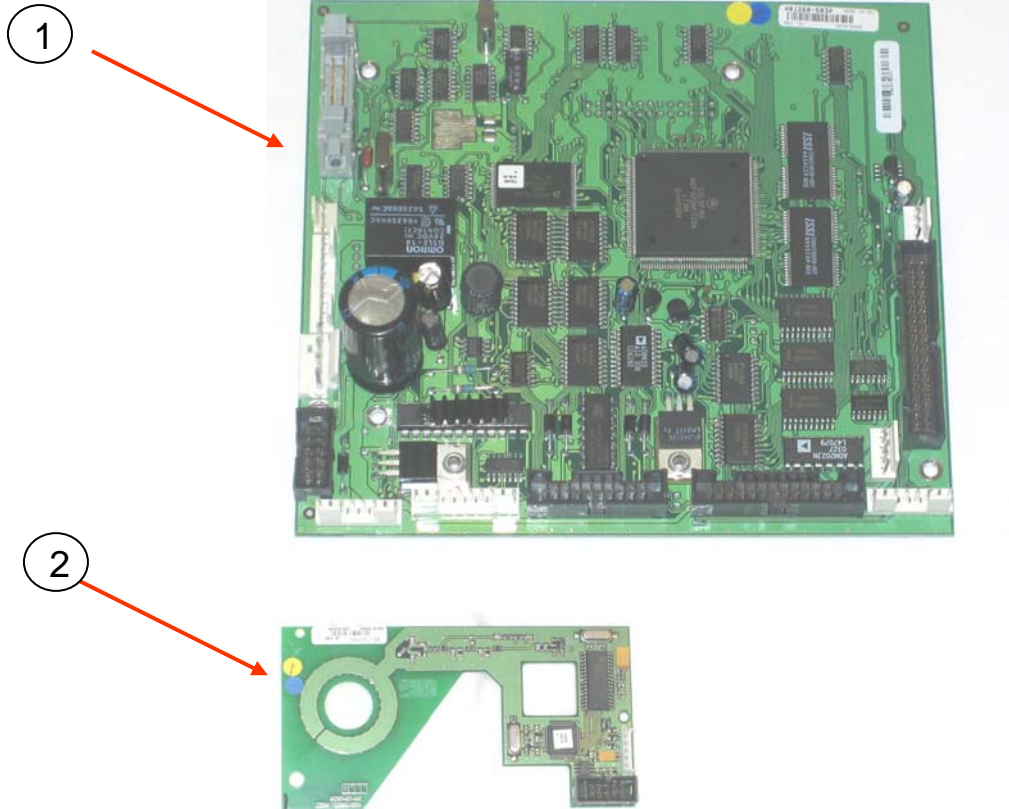

Item	Kit Number	Description	Price
1	105912-501	PCBA Cold Fire Tested CPU (P320i, P420i, P520i)	600.00
2	105912-628	PCBA RFID Reader	111.00

PRINT ENGINE REAR VIEW

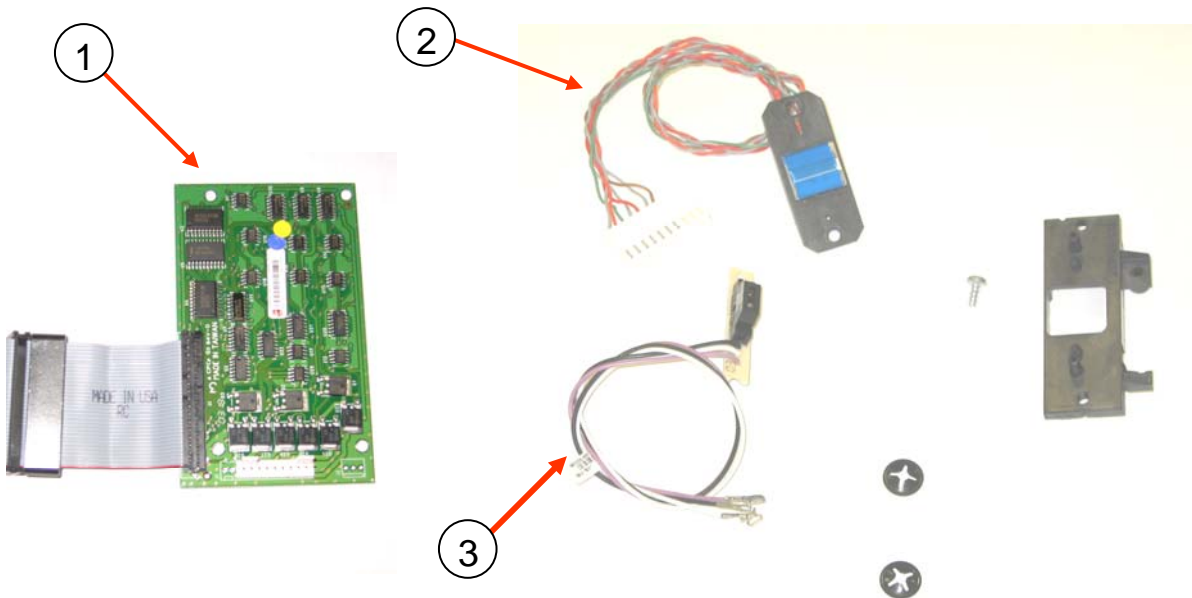

Item #	Kit Number	Description	Price
1	105912-025	PCBA Magnetic Card Writer	230.00
	105912-027	Complete Encoder Stripe Down C & I series	500.00
	105912-028	Complete Encoder JIS II Stripe Down Obsolete	11480.00
2	105912-029	Encoder Stripe Down (Encoder Only)	369.00
3	105912-031	PCBA Magnetic Sensor	64.00

PRINT ENGINE REAR VIEW



Kit Number	Description	Price
105912-533	Printhead Kit, Cam assembly	40.00

PRINT ENGINE REAR VIEW



Kit Number	Description	Price
105912-180	Bearing, Ball, Flanged (set of 17)	76.00

PRINT ENGINE REAR VIEW

**P310C and P310i,
P420C, P520C and
P720C is silver model.**



Kit Number	Description	Price
105912-079	Printhead Pressure Spring (Set of 10) Silver	27.00

**For P320i, P420i and P520i the spring is
GOLDEN. Part # 105912-504, 10/kit, at 30.00**

PRINT ENGINE REAR VIEW

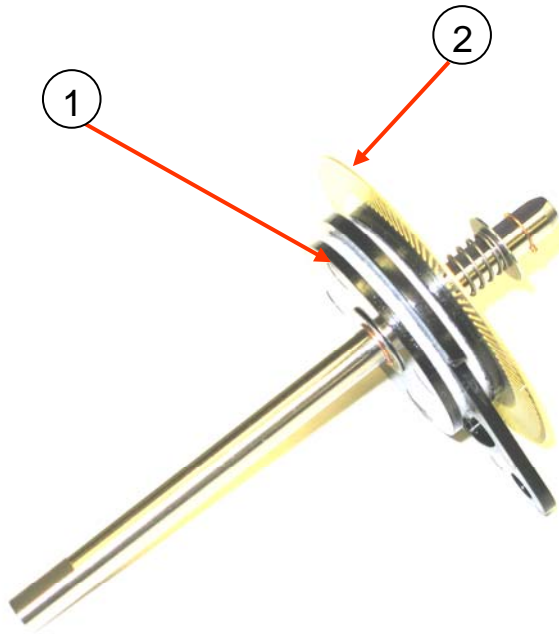

Item #	Kit Number	Description	Price
1	105912-050	Clutch Assembly C series	65.00
2	105912-534	Flag Disk (Only) Set of 5	44.00

PRINT ENGINE REAR VIEW



Kit Number	Description	Price
105912-534	Flag Encoder Disc (only) (set of 5)	44.00

PRINT ENGINE REAR VIEW



Kit Number	Description	Price
105912-538	Cam Follower Arm (set of 5)	27.00

PRINT ENGINE REAR VIEW



Kit Number	Description	Price
105912-543	Kit, Head Load Lever P310	29.00

PRINT ENGINE REAR VIEW

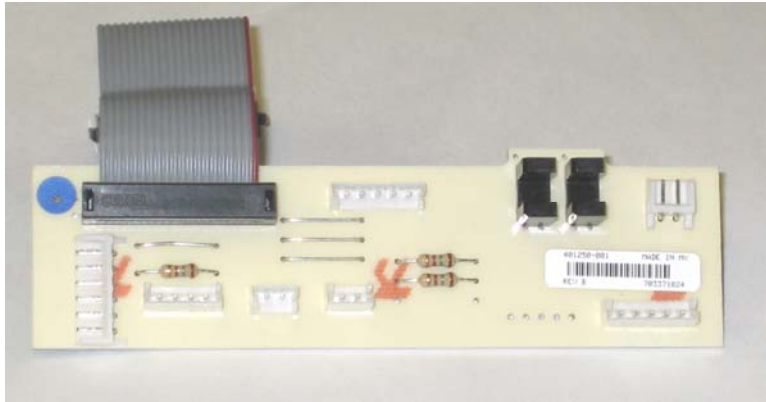

Kit Number	Description	Price
105912-020	PCBA Daughter, P310 based Printers	80.00

PRINT ENGINE REAR VIEW



Kit Number	Description	Price
105912-544	Sensor Retaining Fastener (Obsolete)	23.00

PRINT ENGINE REAR VIEW

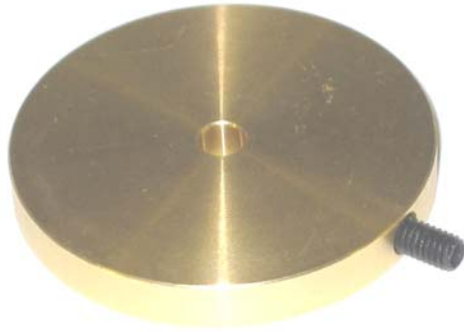

Kit Number	Description	Price
105912-545	Inertia Roller/set screw	27.00

PRINT ENGINE REAR VIEW

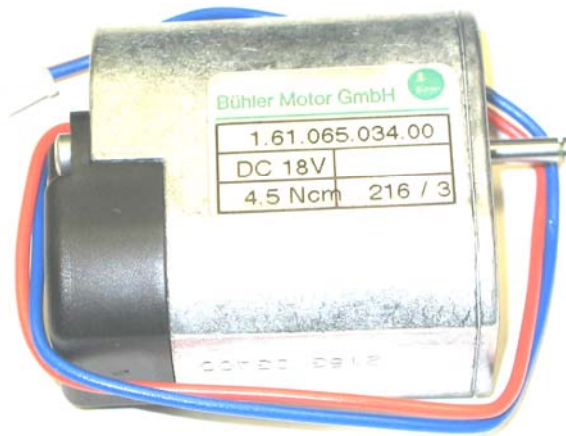

Item #	Kit Number	Description	Price
1	105912-006	DC Motor and Cable low torque	85.00
1A	105912-787	DC Motor and Cable high torque	85.00

PRINT ENGINE REAR VIEW



Kit Number	Description	Price
105909-103	Motor, Stepper and Cable	209.00

PRINT ENGINE REAR VIEW



Kit Number	Description	Price
105909-040	Stepper Motor Drive Belt Kit (set of 5)	58.00

PRINT ENGINE REAR VIEW



Kit Number	Description	Price
105912-546	Head Up/Dwn Cam/W Screw (Set of 5)	27.00

PRINT ENGINE REAR VIEW



Kit Number	Description	Price
105912-535	Spring, Head Release (set of 10)	26.00

PRINT ENGINE REAR VIEW



Kit Number	Description	Price
105912-533	Printhead Kit, Cam assembly	40.00

PRINT ENGINE REAR VIEW

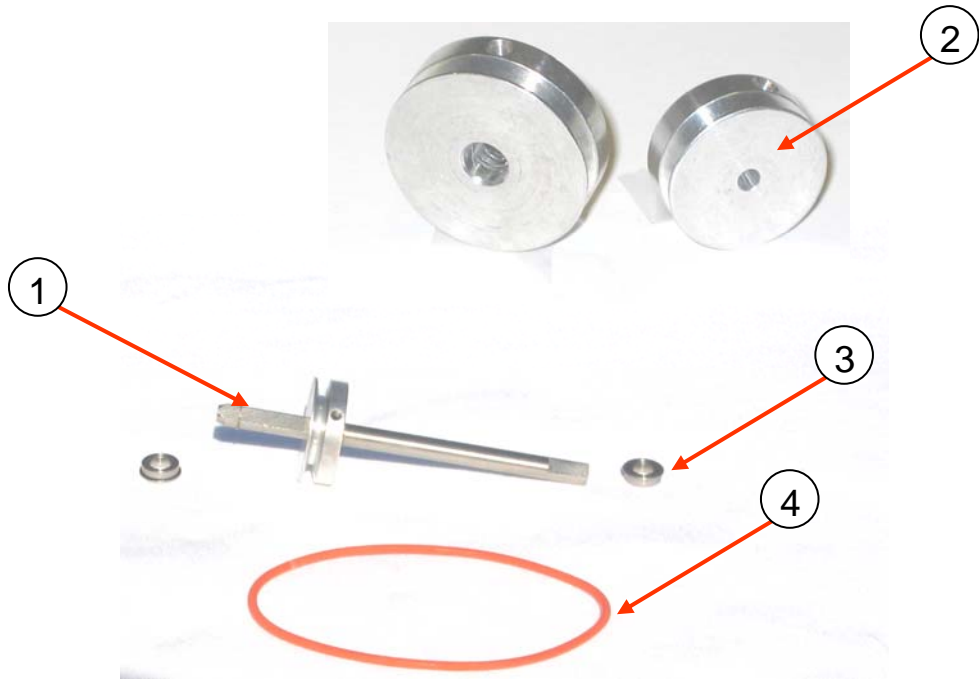

* = Item Not Shown

Item #	Kit Number	Description	Price
1	105912-017	Ribbon Take up Pulley & Shaft (upper)	57.00
2	105912-537	Ribbon Take up Pulley Lower (set of 5)	30.00
3	105912-180	Bearing, Ball, Flanged (set of 17)	76.00
4	105909-038	Ribbon Take Up O-Ring Kit (set of 5)	37.00

PRINT ENGINE REAR VIEW

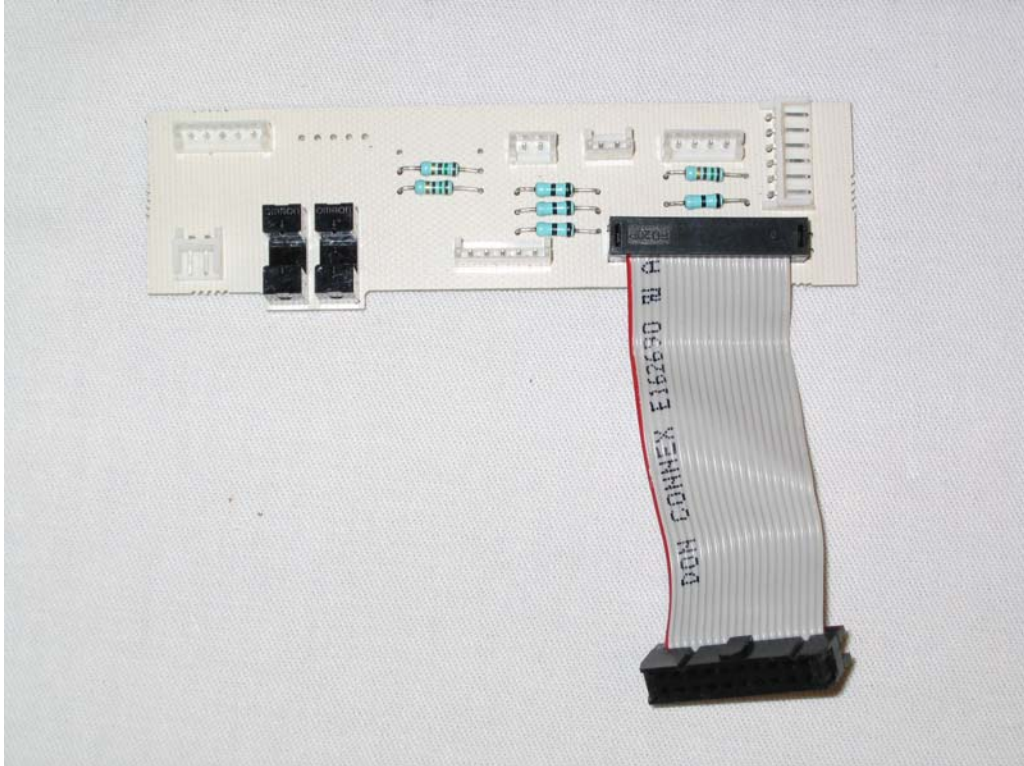

Kit Number	Description	Price
105912-020	PCBA Daughter, P310 based Printers	80.00

PRINT ENGINE REAR VIEW

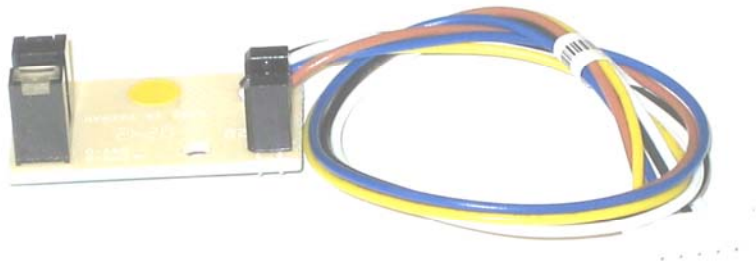

Kit Number	Description	Price
105912-016	PCBA Film & Bracket Sensor c series	58.00
105912-067	PCBA Film & Bracket Sensor I series	58.00

PRINT ENGINE REAR VIEW



Kit Number	Description	Price
105912-551	Upper Cam, Print Engine (set of 5)	27.00

PRINT ENGINE REAR VIEW



Kit Number	Description	Price
105912-539	Washer Wavy 400 x 575 (set of 20)	24.00

PRINT ENGINE REAR VIEW



Kit Number	Description	Price
105912-550	KEPS Nut /Washer (Obsolete)	20.00

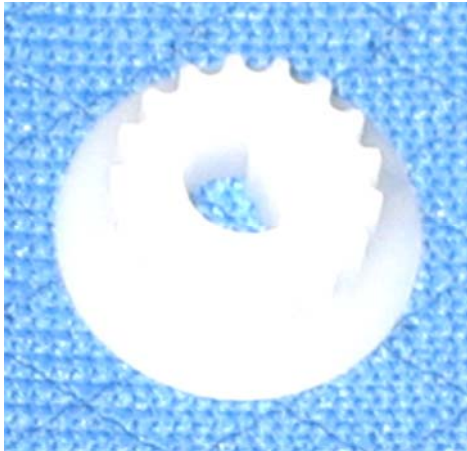

Kit Number	Description	Price
105912-549	Pulley, White, 17T 5mm ID (Set of 10)	23.00

PRINT ENGINE



Kit Number

Description

Price

105912-548	Plastic Cable Clip	29.00
-------------------	--------------------	-------

P310 and P310i

Card Feeder Module

P310 &P310i Card Feeder Module

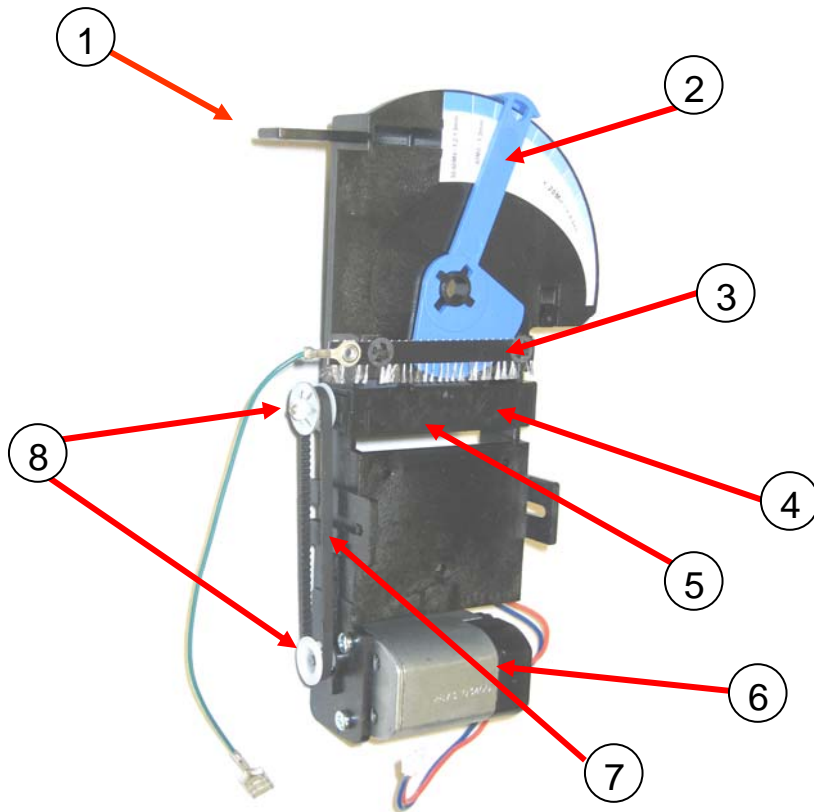

Item #	Kit Number	Description	Price
1	105912-023	CARD FEEDER COMPLETE (shown)	299.00
2	105912-522	ARM DIAL P310 (Set of 5)	28.00
3	105912-521	ESD BRUSH 70MM (Set of 5)	29.00
4	105912-520	Roller Clamp P310	27.00
5	105912-022	CARD FEEDER ROLLER & PULLEY	45.00
6	105912-006	DC Motor Low Torque	85.00
7	105912-019	TIMING BELT 90T x 1/8" (set of 5)	32.00
8	105912-525	PULLEY PGGT 17T-3MM (10 per kit)	29.00

P310 &P310i Card Feeder Module

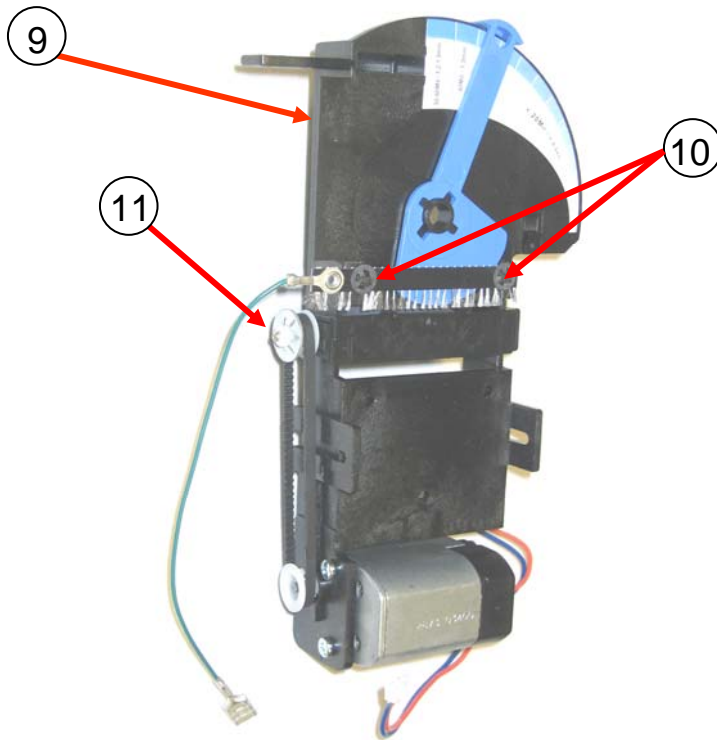

Item #	Kit Number	Description	Price
9	105912-511	Feeder, Plastic Frame P310	26.00
10	105912-531	RING 03 SELFLOC 875 (set of 20)	23.00
11	105912-530	PUSH NUT 6MM (set of 20)	27.00

P310 &P310i Card Feeder Module

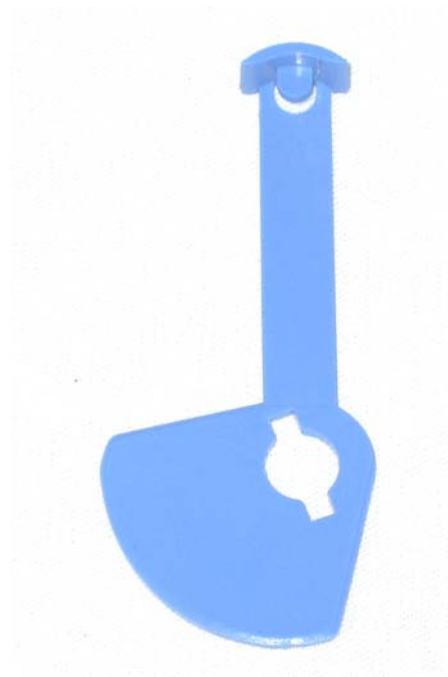

Kit Number	Description	Price
105912-522	ARM DIAL P310 (Set of 5)	28.00

P310 &P310i Card Feeder Module

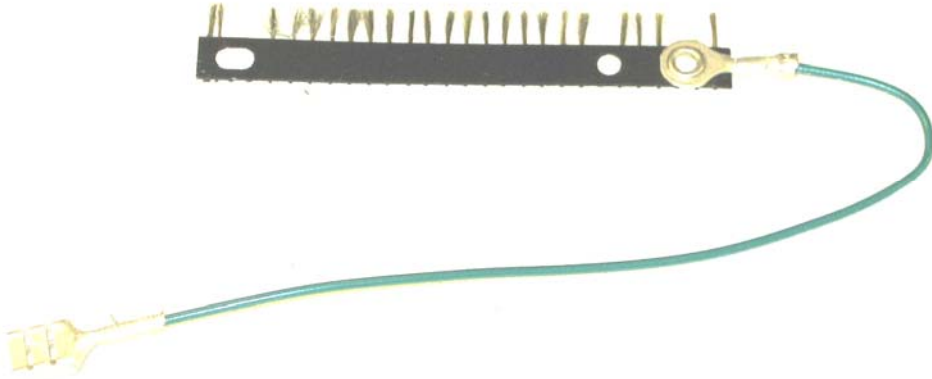

Kit Number

Description

Price

105912-521

ESD BRUSH 70MM (Set of 5)

29.00

P310 &P310i Card Feeder Module

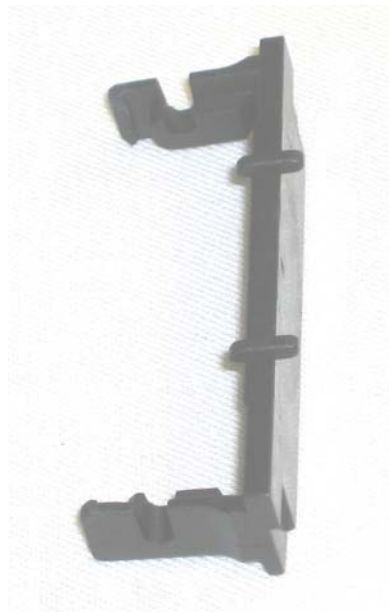

Kit Number

Description

Price

105912-520

ROLLER CLAMP P310

27.00

P310 &P310i Card Feeder Module

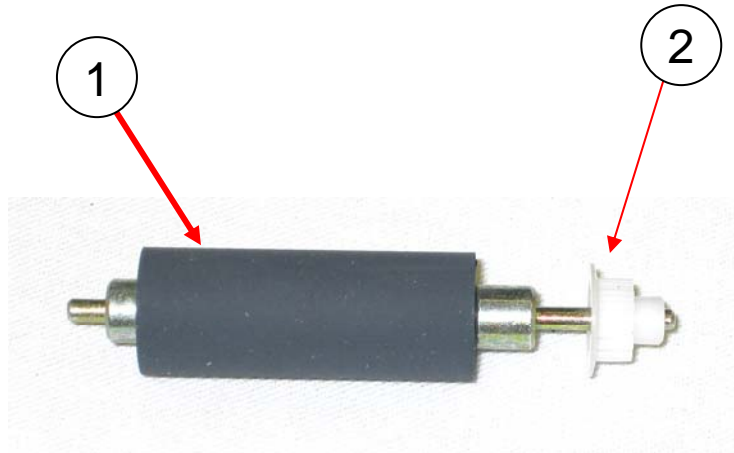

Item #	Kit Number	Description	Price
1	105912-022	CARD FEEDER ROLLER & PULLEY	45.00
2	105912-525	PULLEY PGGT 17T-3MM (set of 10)	29.00

P310 &P310i Card Feeder Module

1

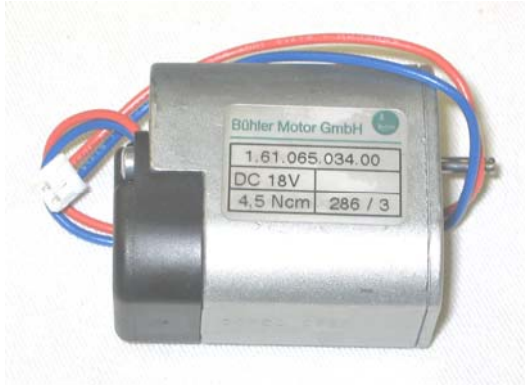

2



Item #	Kit Number	Description	Price
1	105912-006	DC Motor Low Torque	85.00
2	105912-525	PULLEY PGGT 17T-3MM (set of 10)	29.00

P310 &P310i Card Feeder Module

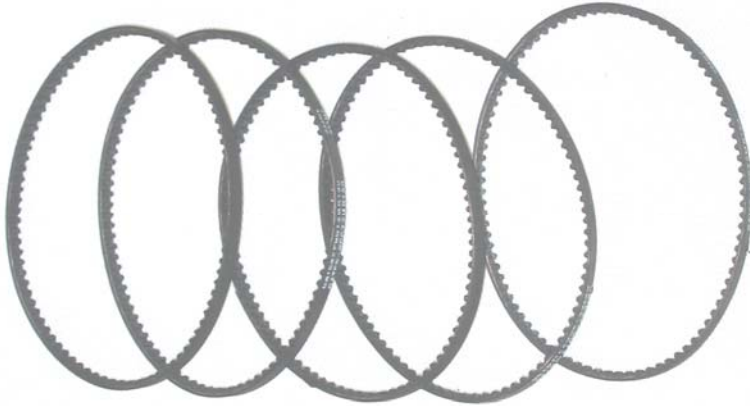

Kit Number	Description	Price
105912-019	TIMING BELT 90T x 1/8" (set of 5)	32.00

P310 &P310i Card Feeder Module



Kit Number

Description

Price

105912-511

Feeder, Plastic Frame P310

26.00

P310 &P310i Card Feeder Module



Kit Number	Description	Price
105912-531	RING 03 SELFLOC 875 (set of 20)	23.00

P310 &P310i Card Feeder Module



Kit Number	Description	Price
105912-530	PUSH NUT 6MM (set of 20)	27.00

P310 &P310i Card Feeder Module

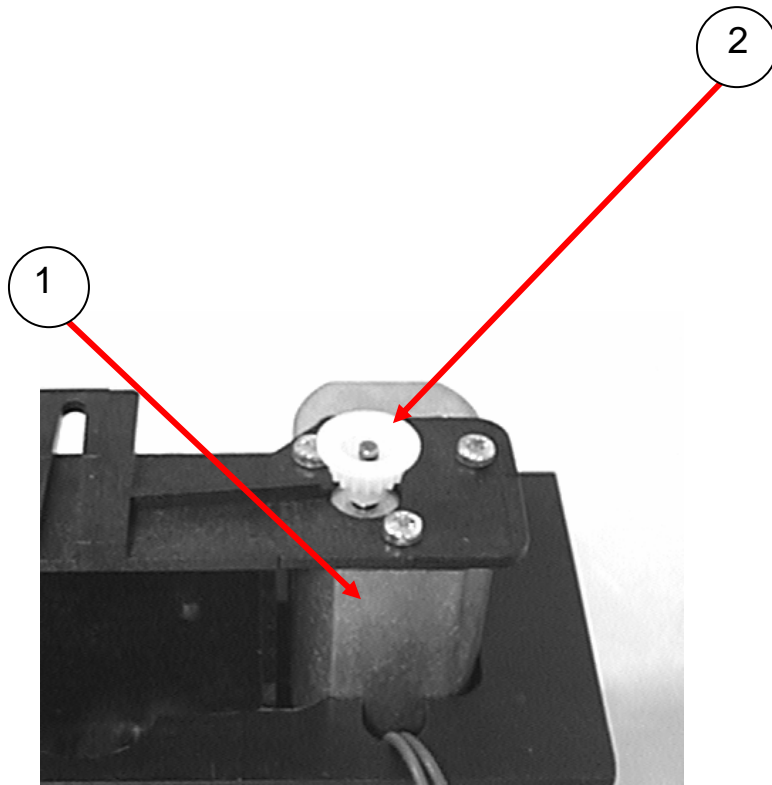

Item #	Kit Number	Description	Price
1	105912-006	DC Motor Low Torque	85.00
2	105912-525	PULLEY PGGT 17T-3MM (set of 10)	29.00

P310 &P310i Card Feeder Module

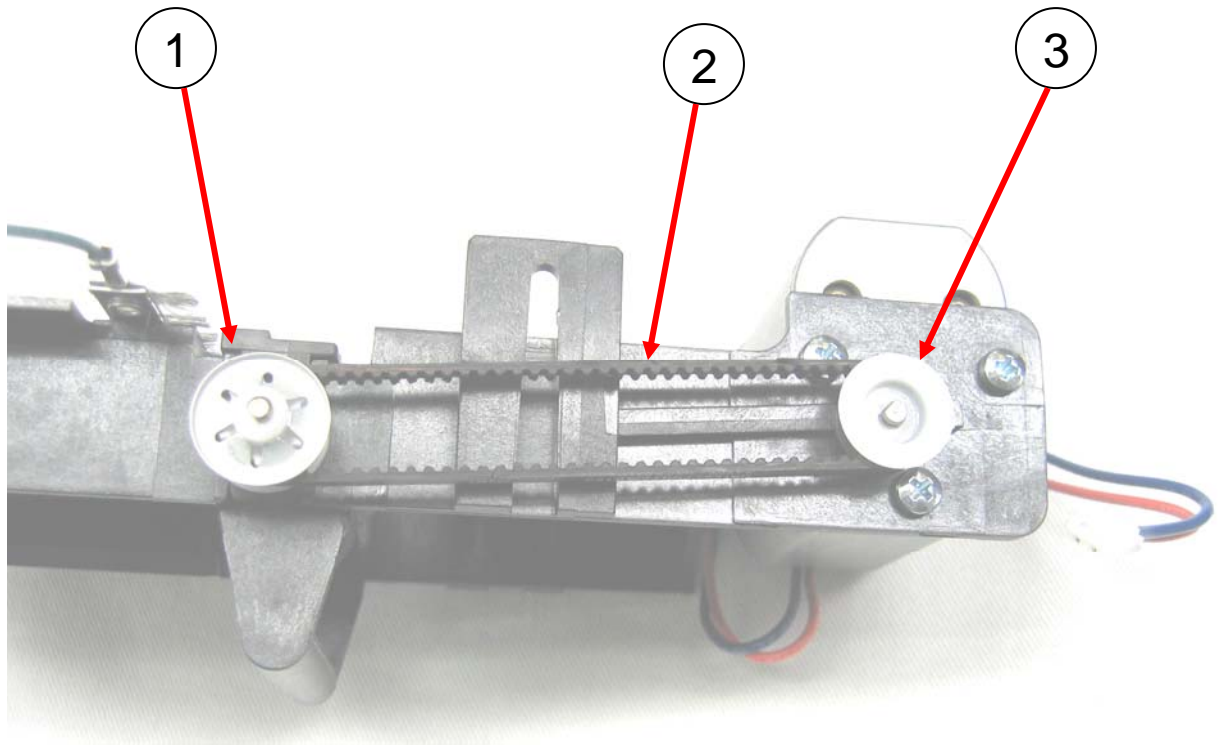

Item #	Kit Number	Description	Price
1	105912-530	PUSH NUT 6MM (set of 20)	27.00
2	105912-019	TIMING BELT 90T x 1/8" (set of 5)	32.00
3	105912-525	PULLEY PGGT 17T-3MM (set of 10)	29.00

P310 &P310i Card Feeder Module

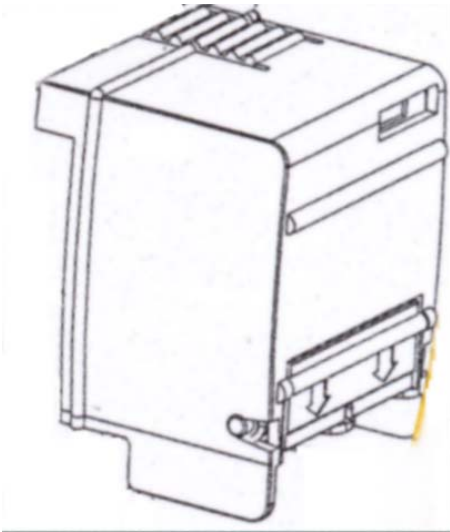

Kit Number	Description	Price
105912-024	Cassette Feeder Kit	77.00

Power Supply Modules

For the C and I series,
excluding the
P330i/P430i, P1x and
P630i/P640i

**P310, P420 and P520 POWER SUPPLY including
the I series P310i, P320i, P420i, P520i**



Item #	Kit Number	Description	Price
--------	------------	-------------	-------

1	105909-020	POWER SUPPLY (2 in P520/P520i)	211.00
	105912-105	Power Supply Repl Kit for Older Printers	226.00
2	105909-032	Fuse AC Power (Set of 10)	35.00

**P310, P420 and P520 POWER SUPPLY including
the I series P310i, P320i, P420i, P520i**



Kit Number	Description	Price
105912-906	Kit Cable AC Input P310	24.00

PRINT ENGINE - FRONT VIEW

P310C/I based Printers

PRINT ENGINE (Front View)

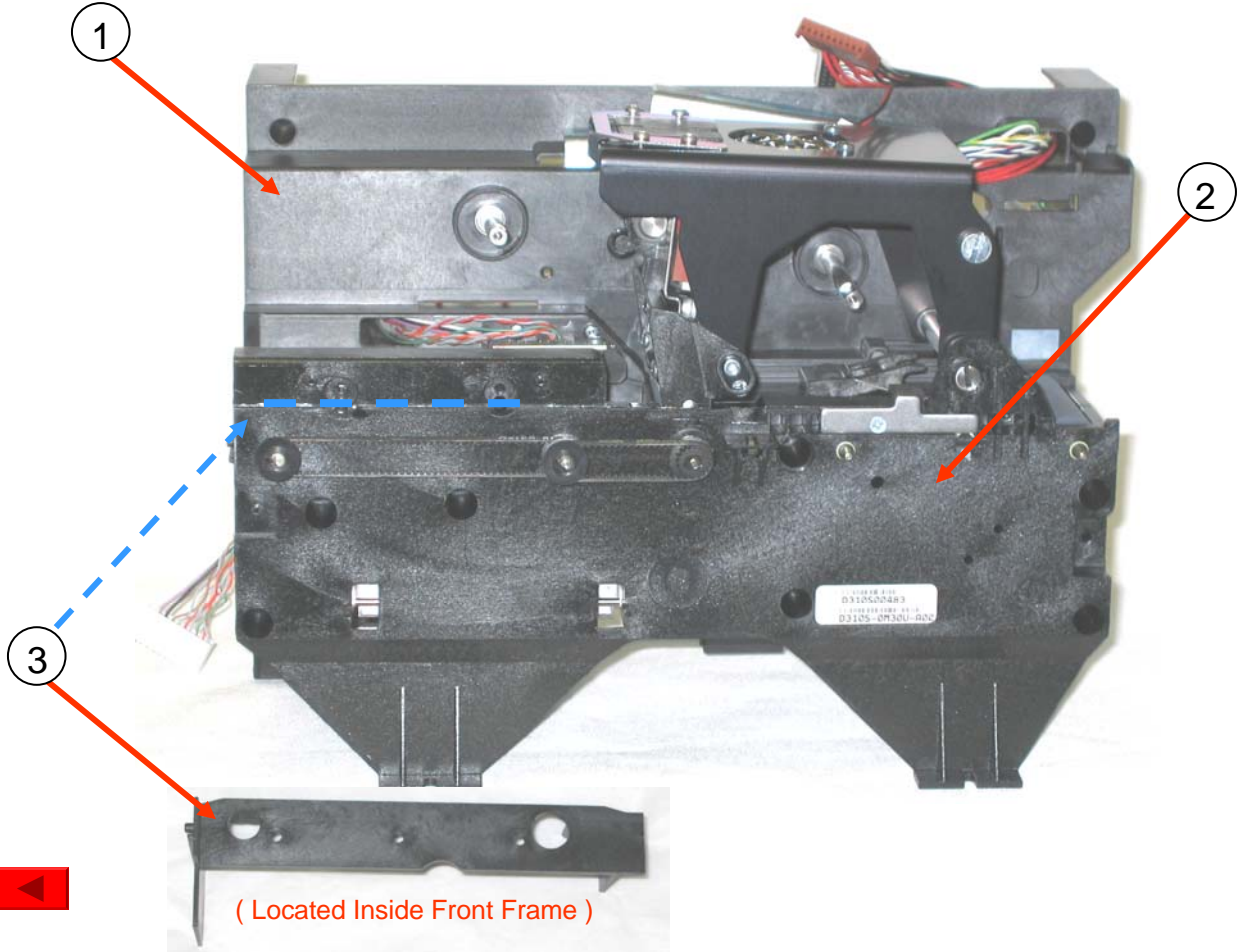

Item #	Kit Number	Description	Price
1	105912-622	Assembly, Center Frame	156.00
2	105912-623	Assembly, Front Frame	139.00
3	105912-624	Card Guide Bias	24.00

**PRINT ENGINE
(Front View)**

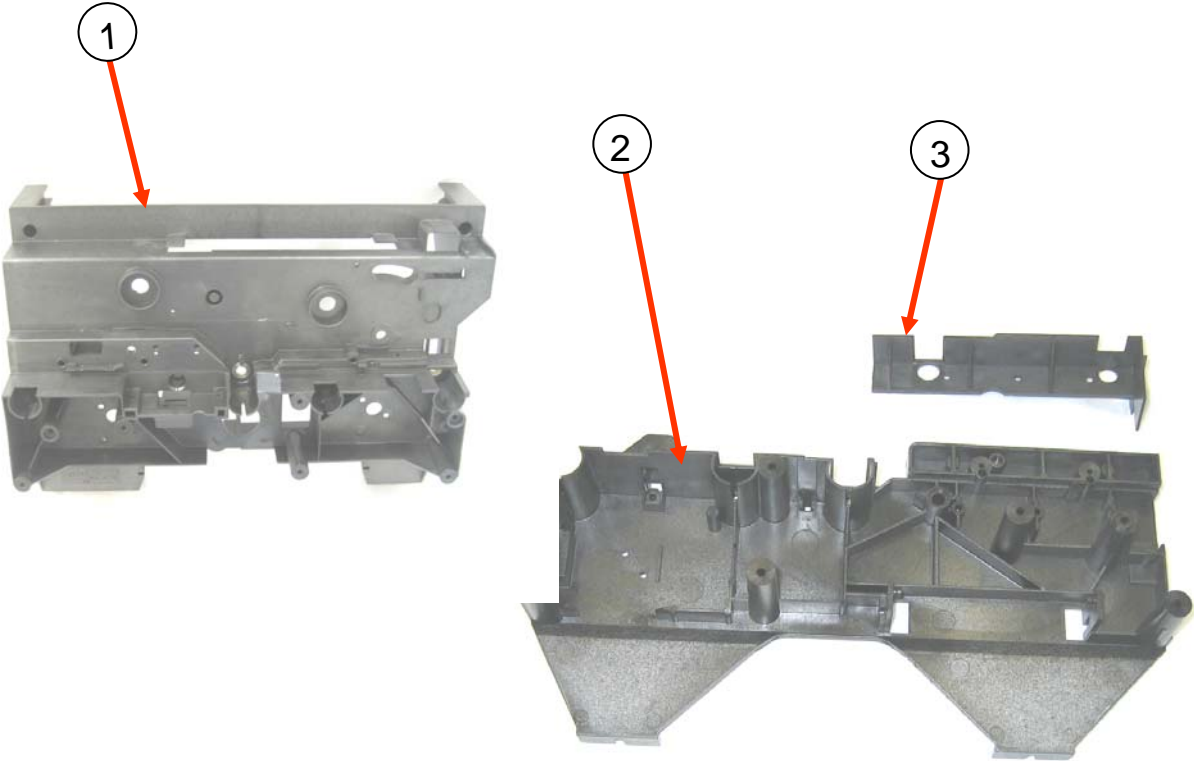

Item #	Kit Number	Description	Price
1	105912-622	Assembly, Center Frame	156.00
2	105912-623	Assembly, Front Frame	139.00
3	105912-624	Card Guide Bias	24.00

PRINT ENGINE

(Front View)

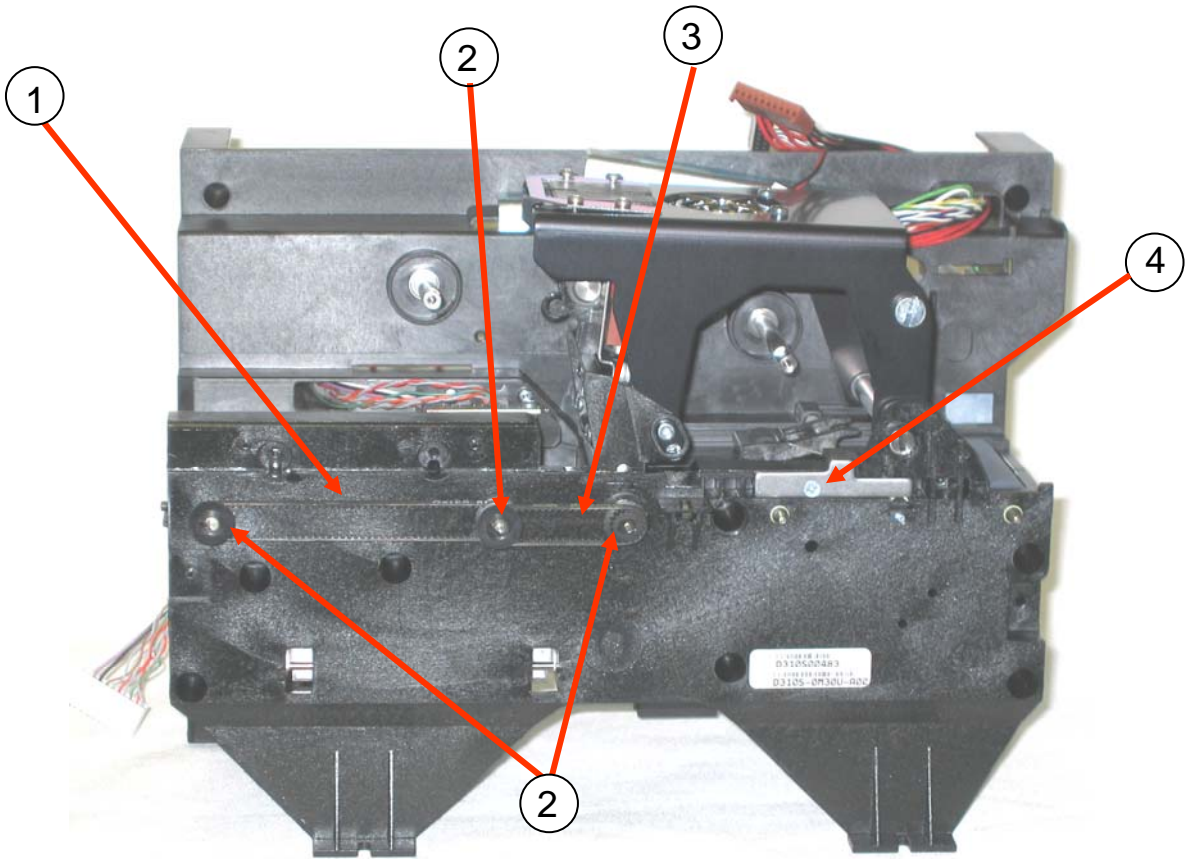

Item #	Kit Number	Description	Price
1	105912-010	Timing Belt Kit 104T x 1/8, 2MR-208-03 (set of 5)	48.00
2	105912-549	Pulley 17T 5mm white (package of 10)	23.00
3	105912-009	Timing Belt Kit 56T x 1/8,2MR-112-03 (set of 5)	30.00
4	105912-527	Kit Retaining, Plate Spring (Set of 5)	33.00

PRINT ENGINE

(Front View)

Print Engine's Belts for Printers based on the P310 Print Engine

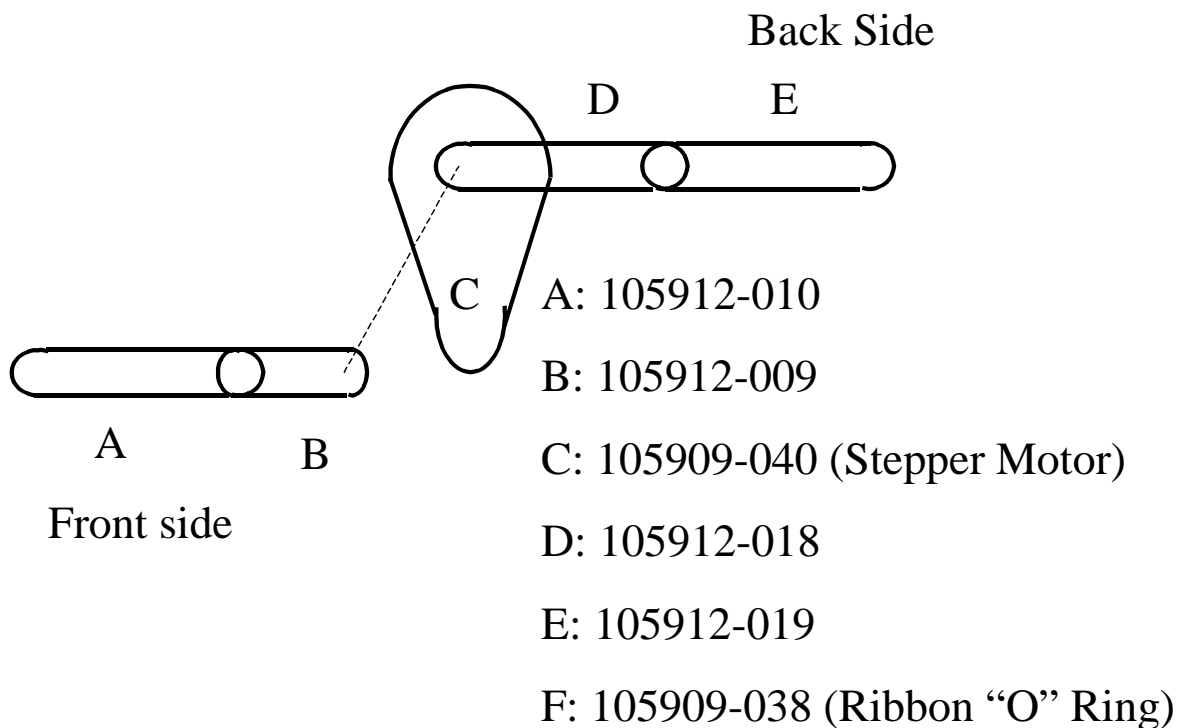

PRINT ENGINE
(Front View)

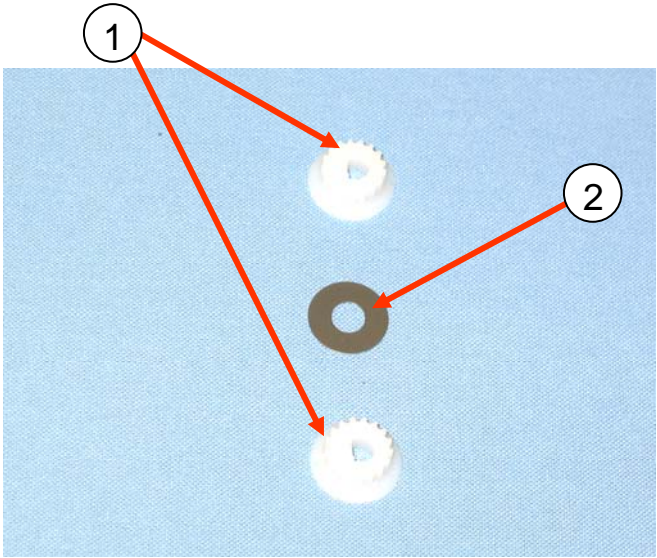

Item #	Kit Number	Description	Price
1	105912-549	Pulley, PGGT 17T 5mm (Set of 10)	23.00
2	105912-575	Spacer Washer, SS Flat (Set of 20)	41.00

PRINT ENGINE (Front View)

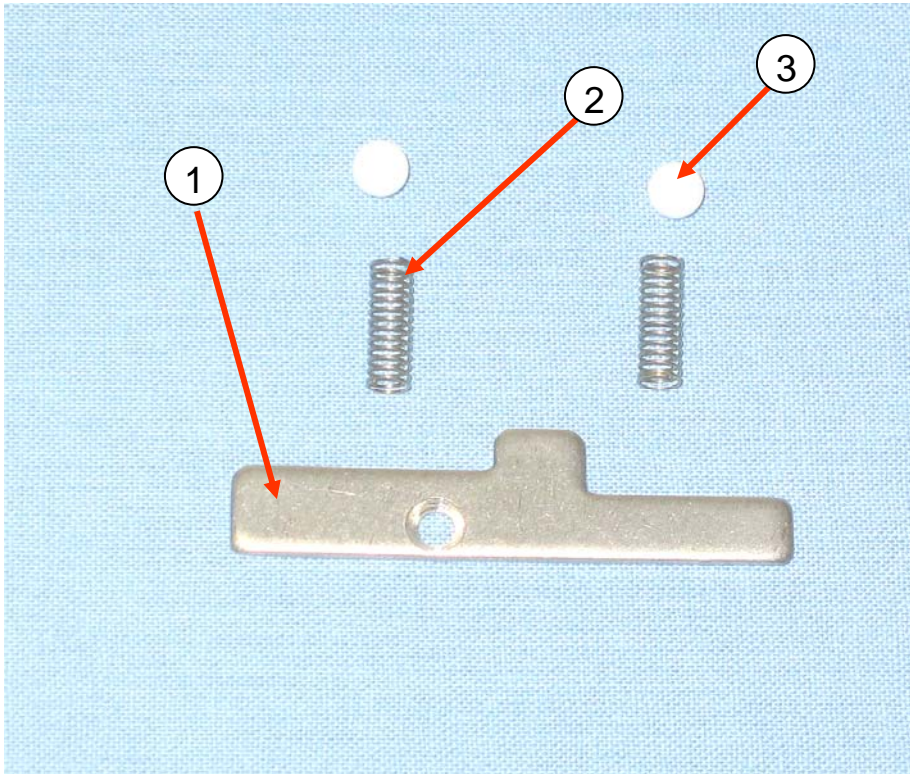

Item #	Kit Number	Description	Price
1	105912-527	Kit, Retaining, Plate SPRG (5/kit)	33.00
2	105912-528	Springs (package of 10)	19.00
3	105912-529	Ball Bearings (package of 20)	29.00

PRINT ENGINE
(Front View)

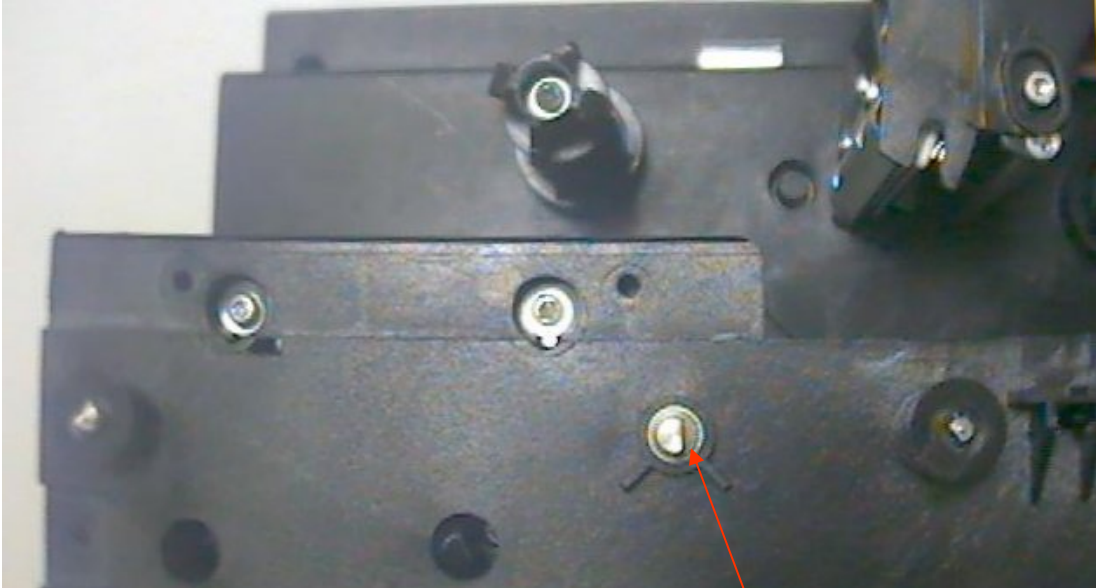

Kit Number	Description	Price
105912-785	Kit Bearing Ball 8x5x2.5 Qty of 5	20.00

PRINT ENGINE - TOP VIEW
P310C/I Printer Models

Print Engine Top View

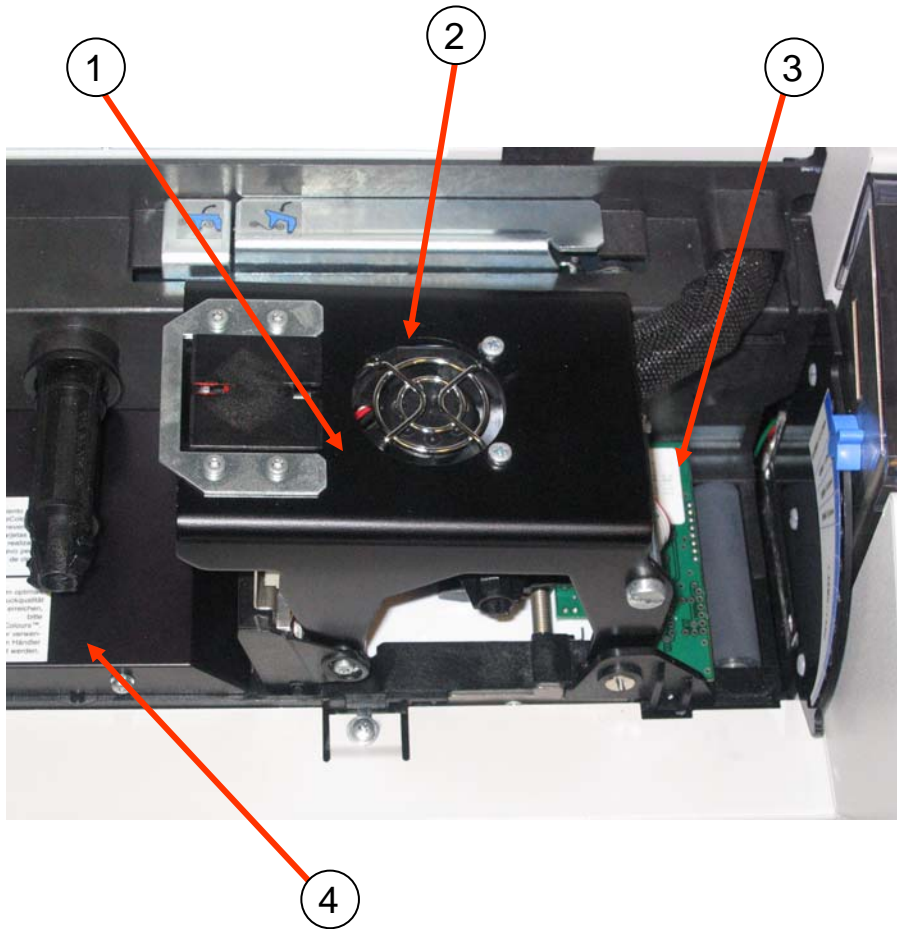

Item #	Kit Number	Description	Price
1	(See next slide)	Print Head U Chassis Assembly	
2	105912-014	P/H Fan Assembly	55.00
3	105912-004	Smart Card Kit	248.00
4	105912-625	Encoder Shroud	24.00

Print Engine Top View

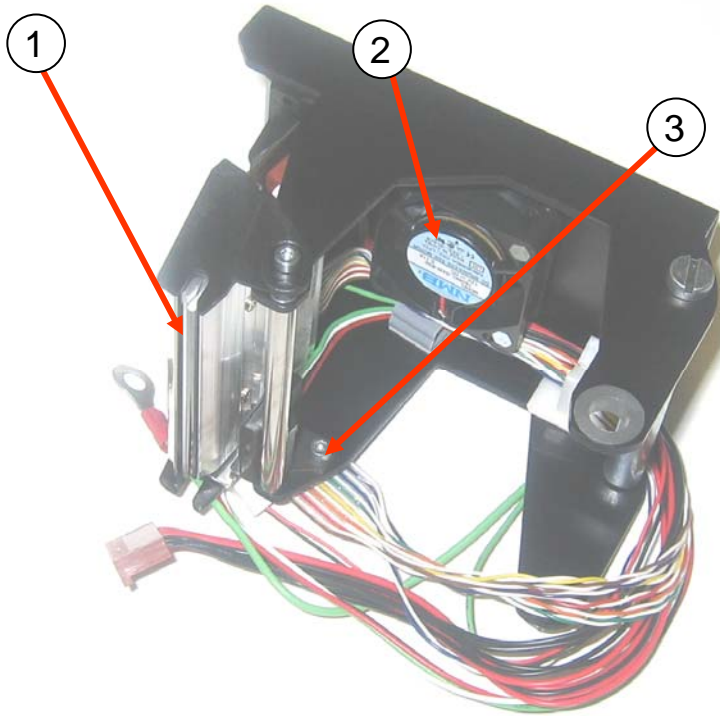

Item #	Kit Number	Description	Price
1	105909-112	Printhead replacement Kit (FBS)	599.00
2	105912-014	P/H Fan Assembly	55.00
3	105912-062	Ribbon Panel Color Sensor Kit (pkg of 5)	107.00

Print Engine Top View

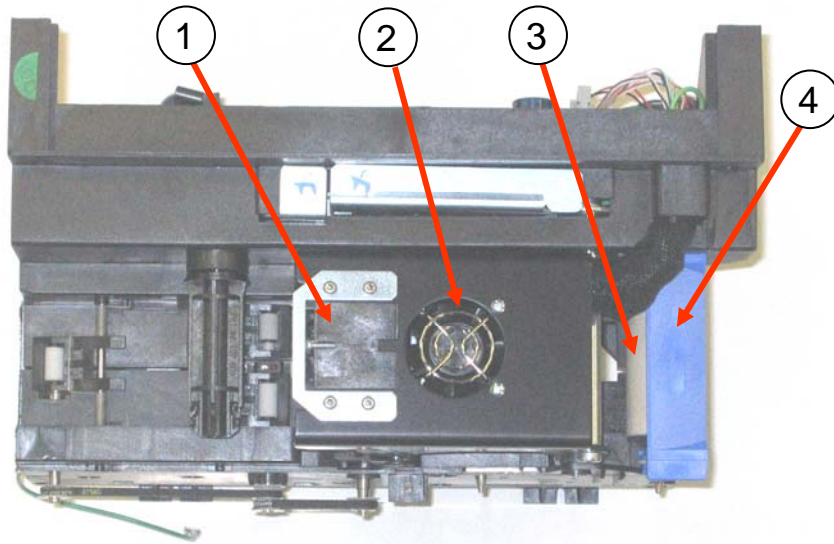

Item #	Kit Number	Description	Price
1	105909-112	Printhead replacement Kit (FBS)	599.00
2	105912-014	P/H Fan Assembly	55.00
3	105912-003	Adhesive Cleaning Roller (pkg of 5)	32.00
4	105912-002	Cleaning Cartridge	Sale's Item

Print Engine Top View

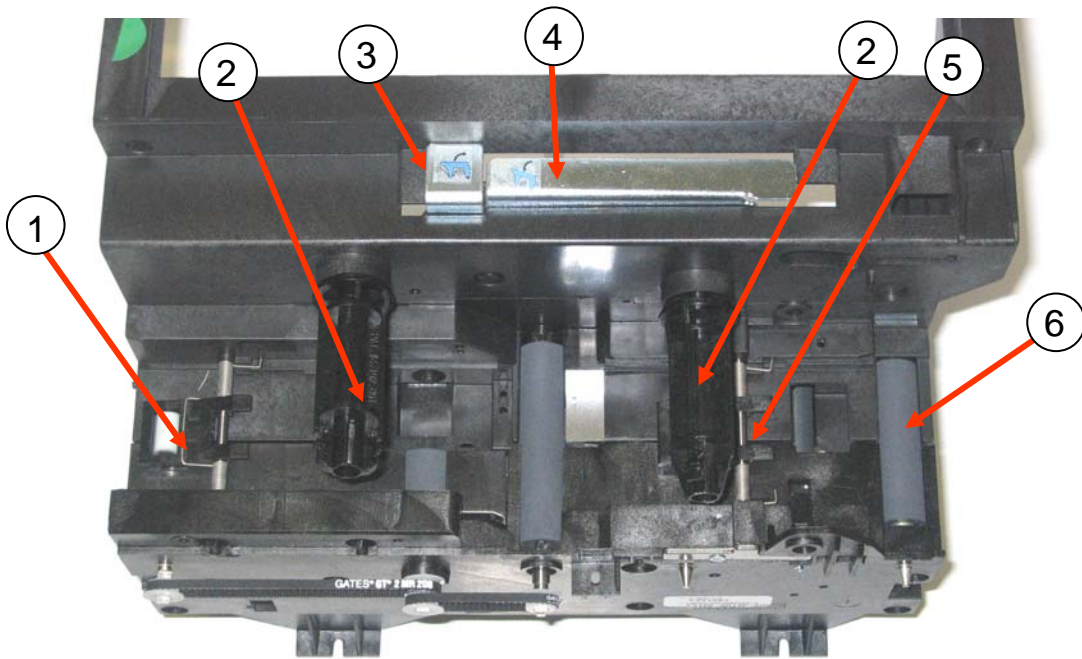

Item #	Kit Number	Description	Price
1	105912-751	Kit Exit Pressure Roller	26.00
2	105912-001	Ribbon Spindles- Molded	38.00
3	105912-536	Pint Head Release Lever	23.00
4	105912-543	Head Load Close Lever	29.00
5	105912-585	Pressure Roller Entry	26.00
6	105912-764	Roller Clean Drive (package of 5)	47.00

P310 Printer Pressure Rollers

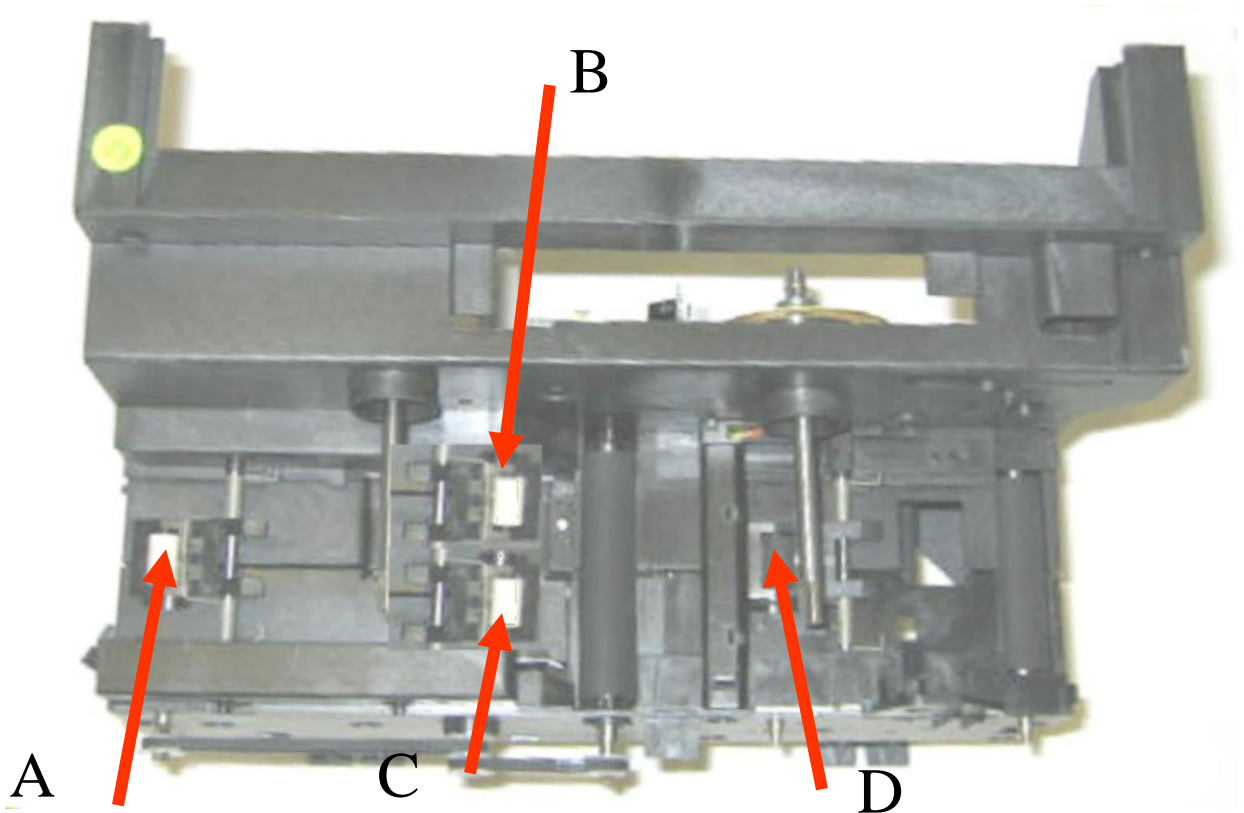

- A: Exit Pressure Roller
 - Part # 105912-751 @ 26.00
- B: Mag Pressure Roller
 - Part # 105912-012 @ 27.00
- C: Assy Pressure Roller
 - Part # 105912-908 @ 26.00
- D: Entry Pressure Roller
 - Part # 105912-585 @ 26.00

Print Engine Top View



Kit Number	Description	Price
105912-751	Kit Exit Pressure Roller	26.00

Print Engine Top View



Kit Number	Description	Price
105912-585	Entry Pressure Roller Kit	26.00

Print Engine Top View

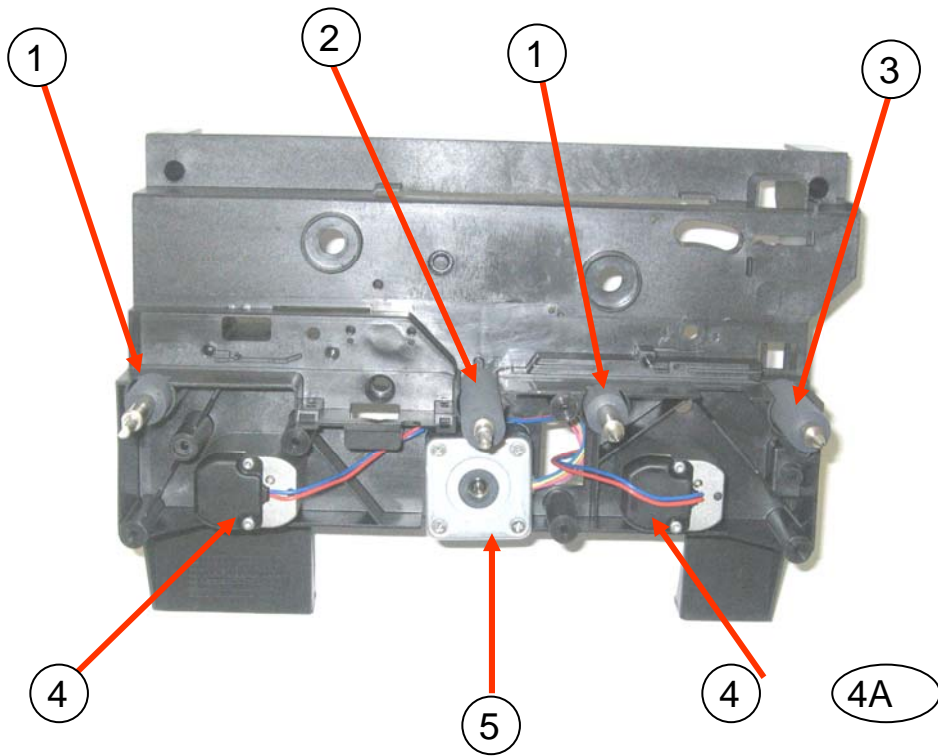

Item #	Kit Number	Description	Price
--------	------------	-------------	-------

1	105912-586	Roller Card Drive (pkg of 5)	45.00
2	105912-590	Roller Print Engine Platen (pkg of 5)	46.00
3	105912-764	Roller Clean Drive (package of 5)	47.00
4	105912-006	Cable Assembly DC Motor low torque	85.00
4A	105912-787	Cable Assembly DC Motor high torque	85.00
5	105909-103	Assy, Stepper Motor/pulley	209.00

Print Engine Top View

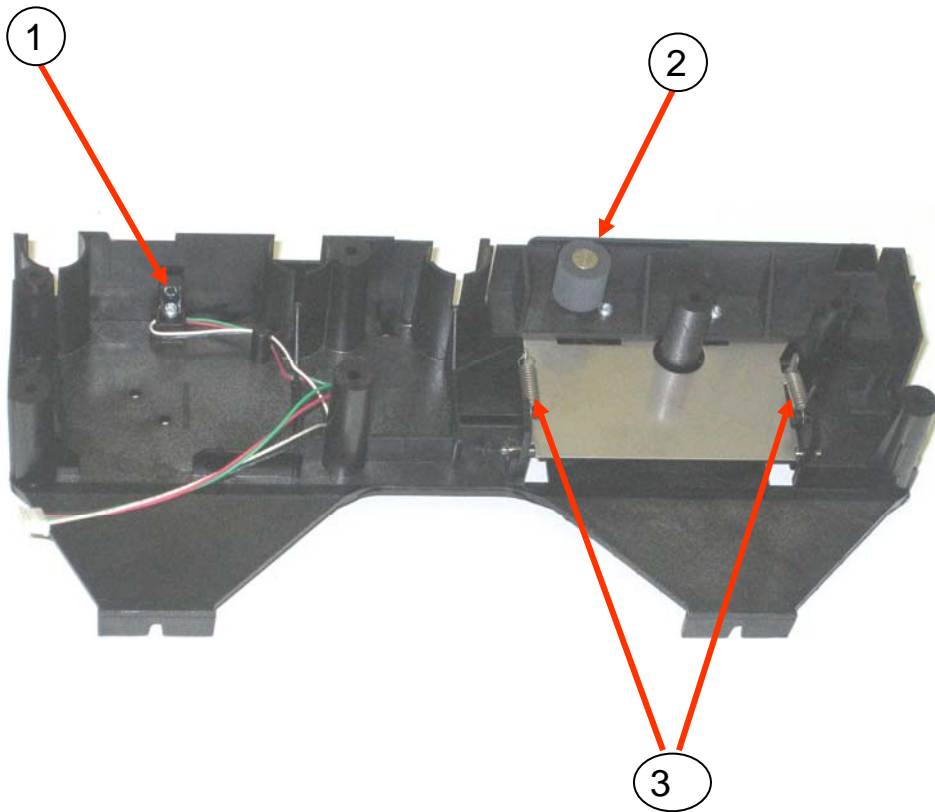

Item #	Kit Number	Description	Price
1	105912-005	Card Sensor Cable Assembly	46.00
2	105912-594	Magnetic Encoder Roller (package of 5)	49.00
3	105912-011	Card Pressure Plate Spring (set of 10)	41.00

Print Engine Top View

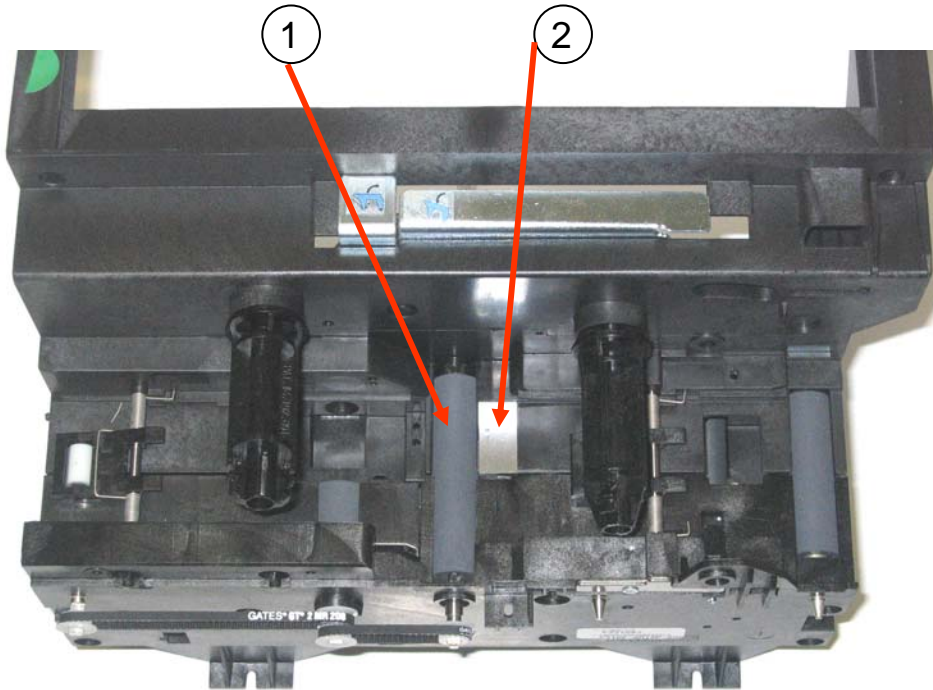

Item #	Kit Number	Description	Price
1	105912-590	Roller P/H Platen (package of 5)	46.00
2	105912-201	Color Sensor Reflective Tape	30.00

Print Engine Top View

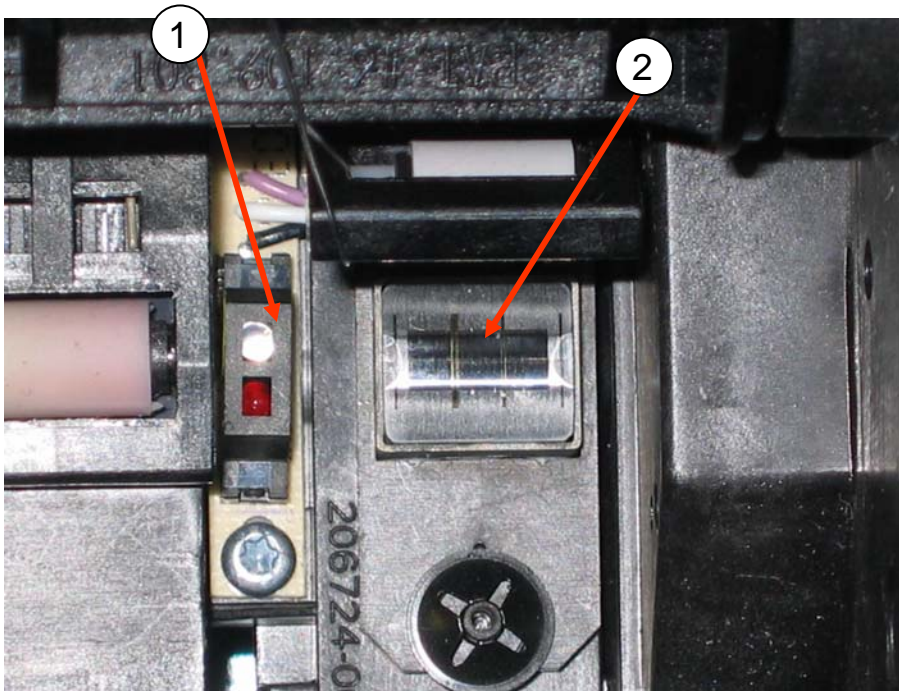

Item #	Kit Number	Description	Price
1	105912-031	PCBA Magnetic Sensor	64.00
2	105912-029	EncStripe Dwn Kit (Encoder Module Only)	369.00

Print Engine Top View

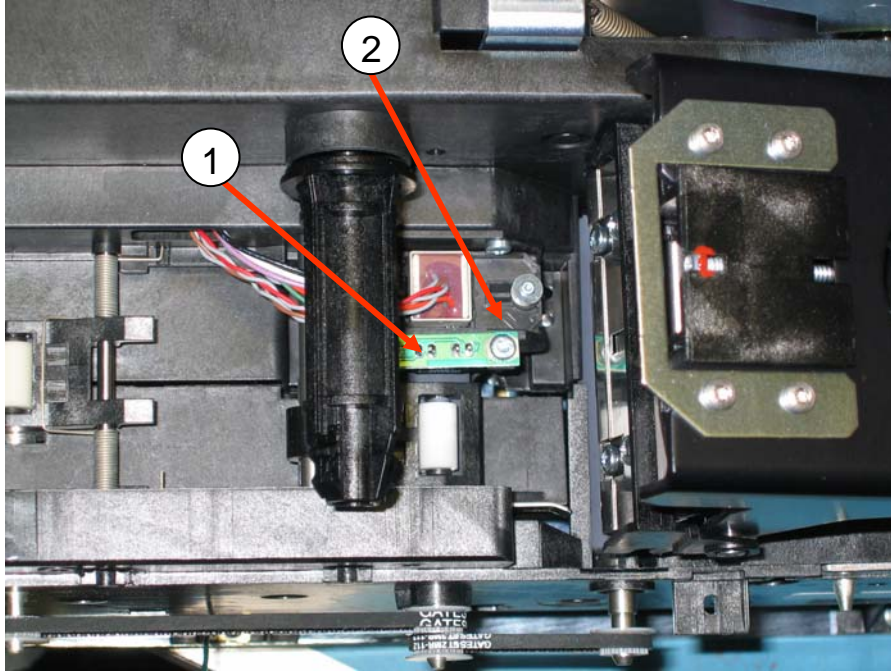

Item #	Kit Number	Description	Price
1	105912-031	PCBA Magnetic Sensor	64.00
2	105912-032	EncStripe Up Kit (Encoder Module Only)	358.00
3	105912-033	Enc JISII S Up Kit (Encoder Module Only)	358.00

2 & 3 for reference only. We do NOT recommend to install it in the field.

Print Engine Top View

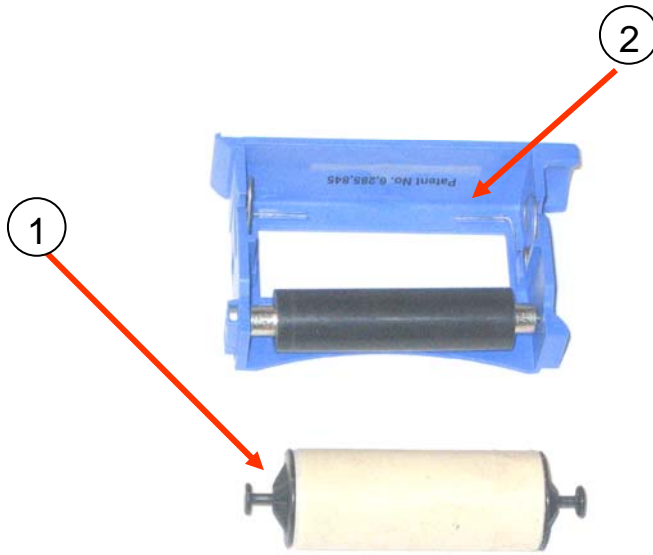

Item #	Kit Number	Description	Price
1	105912-003	Adhesive Cleaning Roller (pkg of 5)	Sale's Item
2	105912-002	Cleaning Cartridge	Sale's Item

Print Engine Top View



Kit Number	Description	Price
105912-586	Roller Card Drive (pkg of 5)	45.00

Print Engine Top View



Kit Number	Description	Price
105912-590	Platen Roller(Printhead)	46.00

Print Engine Top View



Kit Number	Description	Price
105912-764	Roller Clean Drive (package of 5)	47.00

Print Engine Top View



Item #	Kit Number	Description	Price
1	105912-594	Magnetic Encoder Roller (package of 5)	49.00
2	105912-591	Magnetic Encoder Roller, Reversed (EA.)	24.00

Print Engine Top View

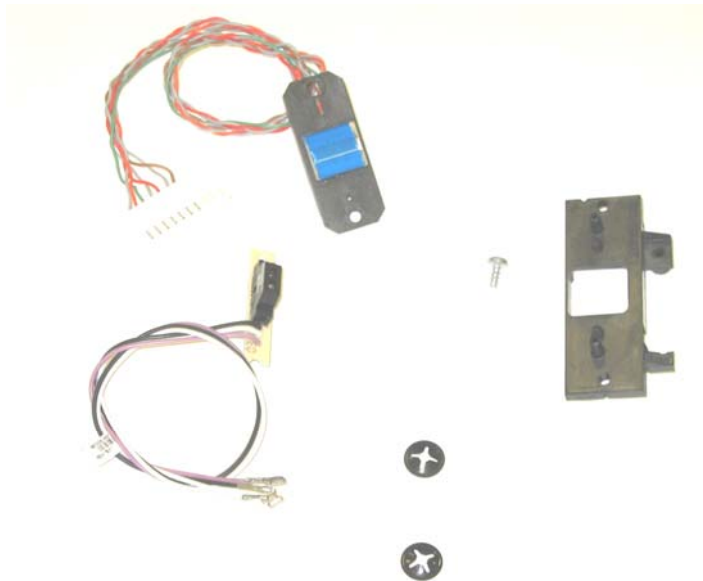

Kit Number	Description	Price
105912-031	PCBA Magnetic Sensor	64.00
105912-029	EncStripe Dwn Kit (Encoder Module Only)	369.00
105912-027	Complete Encoder Stripe Dwn C & I series	500.00

Print Engine Top View



Kit Number	Description	Price
105912-543	P/H Load Close Lever (pkg of 5)	29.00

Print Engine Top View

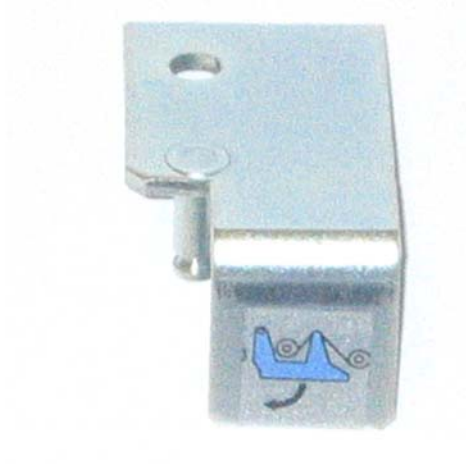

Kit Number	Description	Price
105912-536	P/H Release Lever Kit (PKG OF 5)	23.00

Print Engine Top View



Kit Number	Description	Price
105912-001	Ribbon Spindles- Molded	38.00

Print Engine Top View



Kit Number	Description	Price
105912-005	Card Sensor Cable Assembly	46.00

Print Engine Top View



Kit Number	Description	Price
105912-006	Cable Assembly DC Motor low torque	85.00
105912-787	Cable Assembly DC Motor high torque	85.00

Print Engine Top View



Kit Number	Description	Price
105909-103	Stepper Motor/pulley Assy	209.00

Print Engine Top View

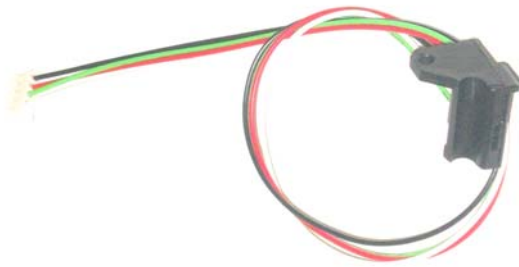

Kit Number	Description	Price
105912-062	Ribbon Panel Color Sensor Kit (pkg of 5)	107.00

Print Engine Top View



Kit Number	Description	Price
105912-625	Encoder Shroud	24.00

Print Engine Top View

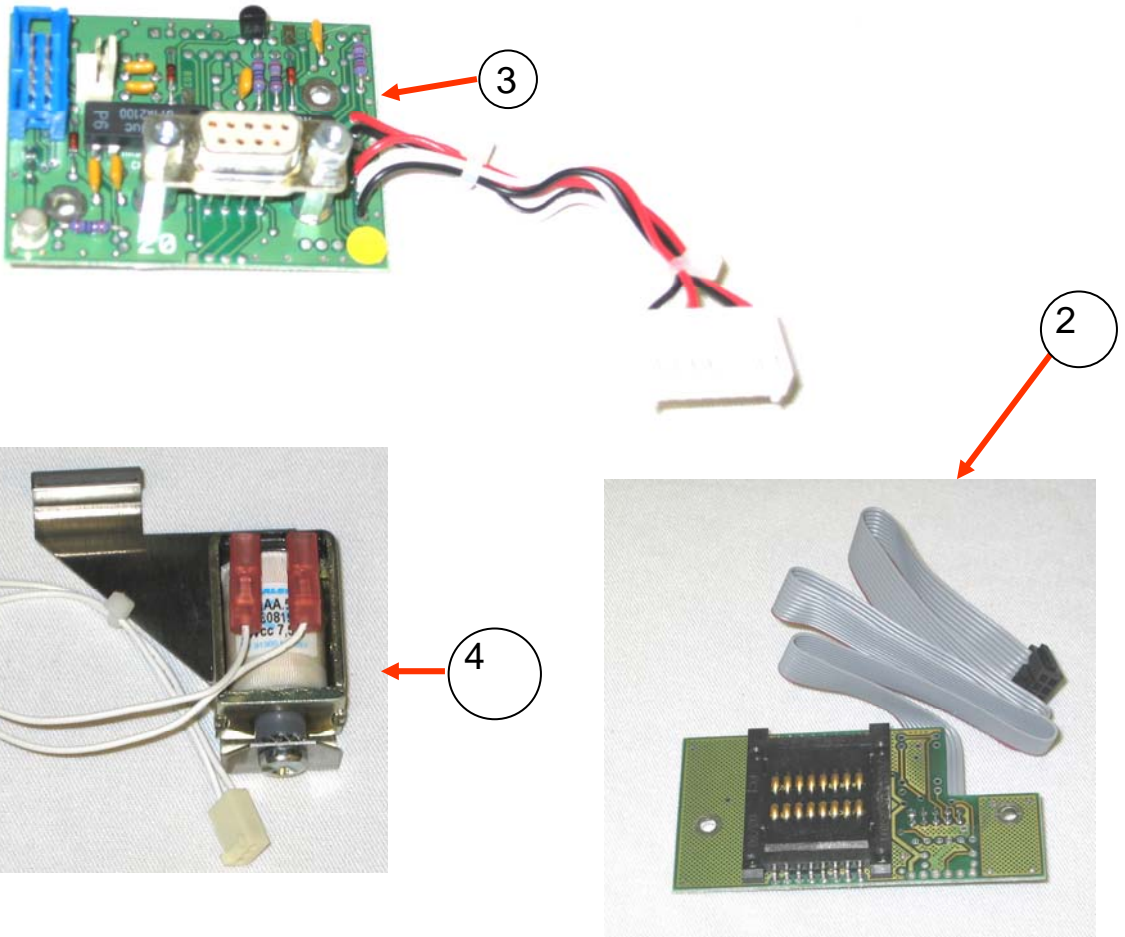

Item #	Kit Number	Description	Price
1	105912-004	Smart Card Kit Complete (includes spring)	248.00
2	105912-717	Smart Card w/Smart Header (Obsolete)	45.00
3	105912-610	PCBA Smart Solenoid	97.00
4	105912-608	Smart Card Solenoid and Plunger Assembly	78.00

Print Engine Top View



Mounted on the FRONT side

Kit Number

Description

Price

105912-911	Kit Clean Cart Clip Smart Card	48.00
------------	--------------------------------	-------

(includes fixing screws)

Print Head Parts
For P310c and
P310i based
printers

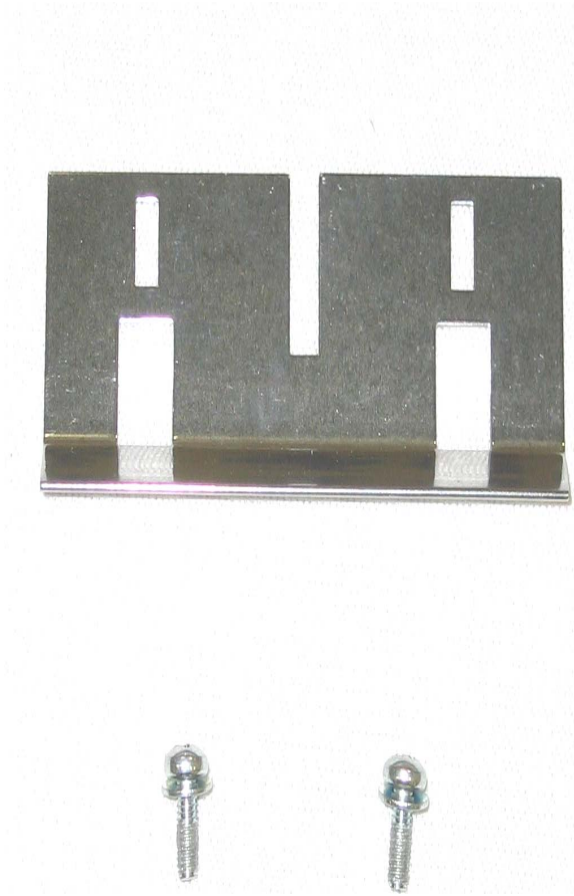

Print Head Peel Bar Kit	105912-517	23.00
-------------------------	------------	-------

PRINT HEAD VIEW

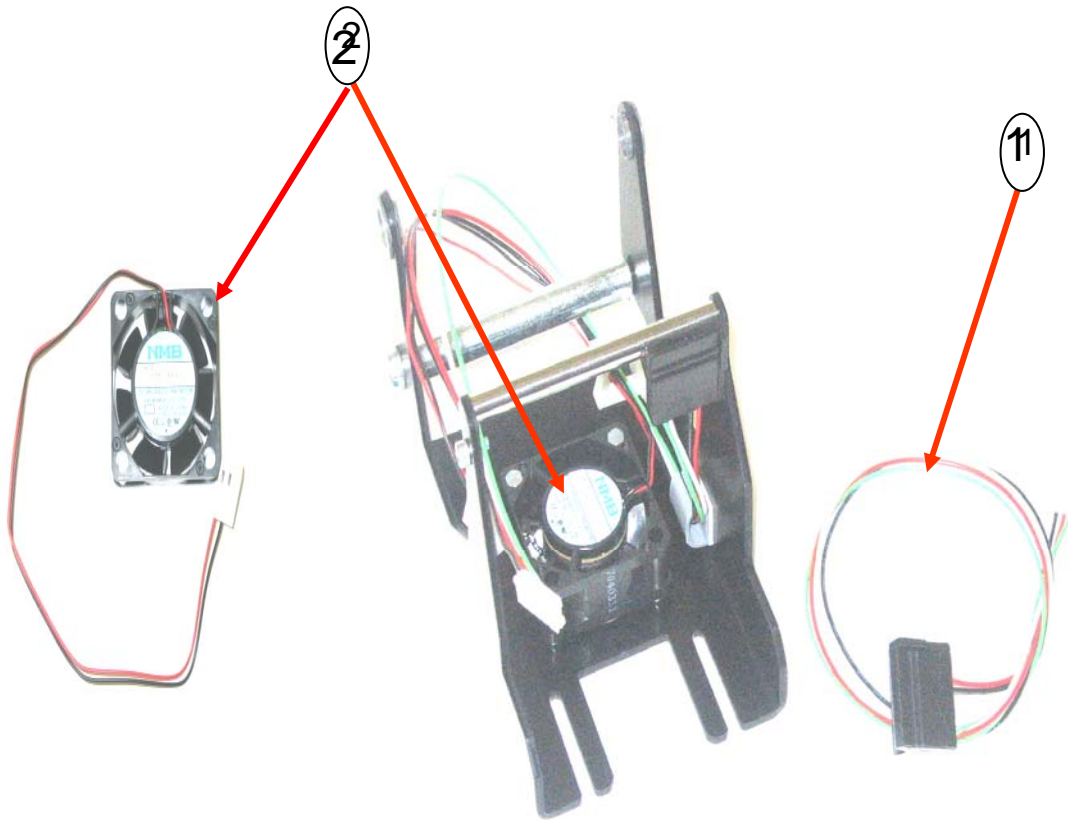

Item #	Kit Number	Description	Price
1	105912-062	Ribbon Panel Color Sensor Kit (pkg of 5)	107.0
2	105912-014	Fan, Print Head	0 55.00

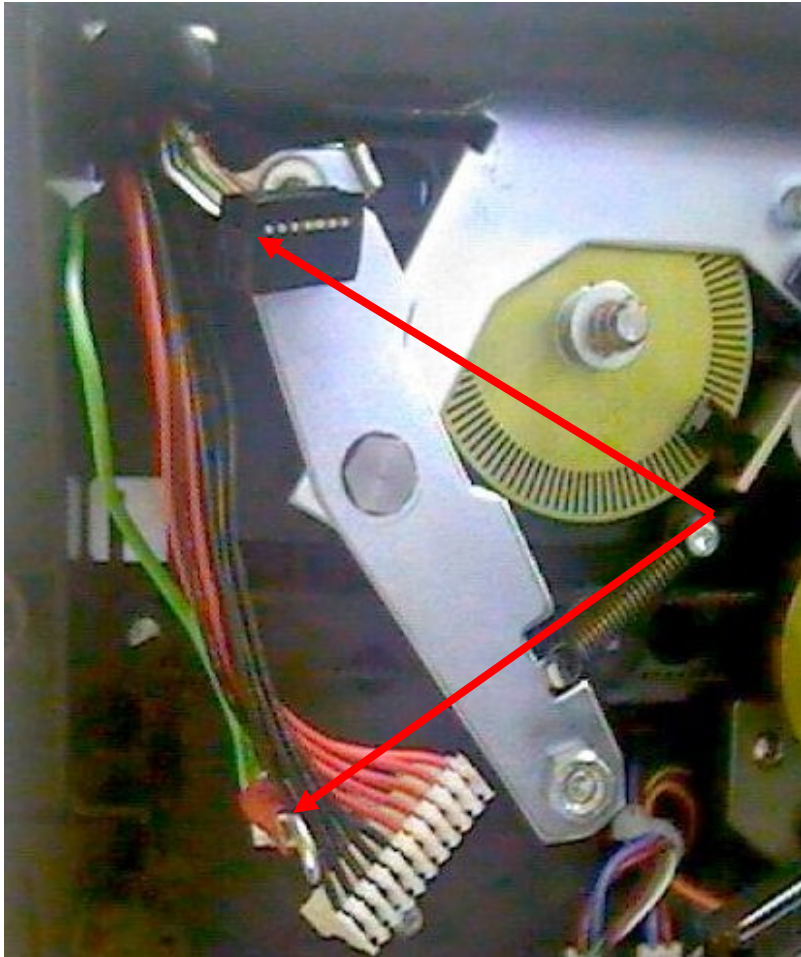

Kit Number

Description

Price

105912-043	Head Cables (Data and power) for C series	56.00
-------------------	--	-------



Kit Number

Description

Price

Kit Number	Description	Price
105912-744	Head Cables (Data only) for I series	47.00

Printer Rear Panel View

P310C/i based Printers

REAR PANEL VIEW

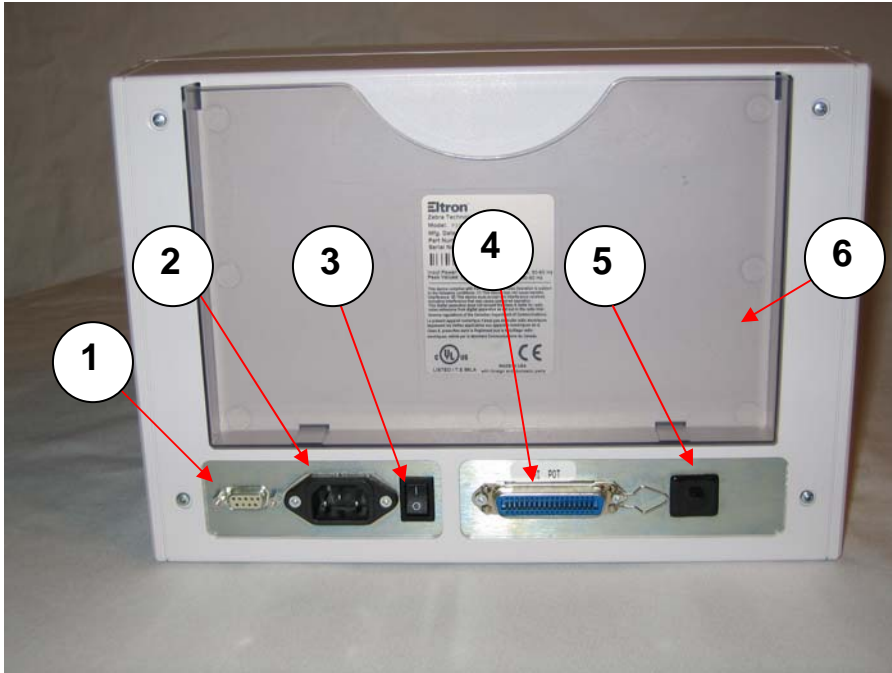

Item #	Kit Number	Description	Price
--------	------------	-------------	-------

1	105912-004	Smart Card Kit	248.00
2	105912-515	AC Receptacle	42.00
3	105912-516	AC Power Switch (Set of 5)	33.00
4	105912-514	Parallel Com. Connector	25.00
5	105912-202	Kit, USB Upgrade, P310C, CP	95.00
5A	105912-583	Kit, USB Upgrade, P310I, CP	95.00
6	105912-034	Manual Holder	34.00

REAR PANEL VIEW

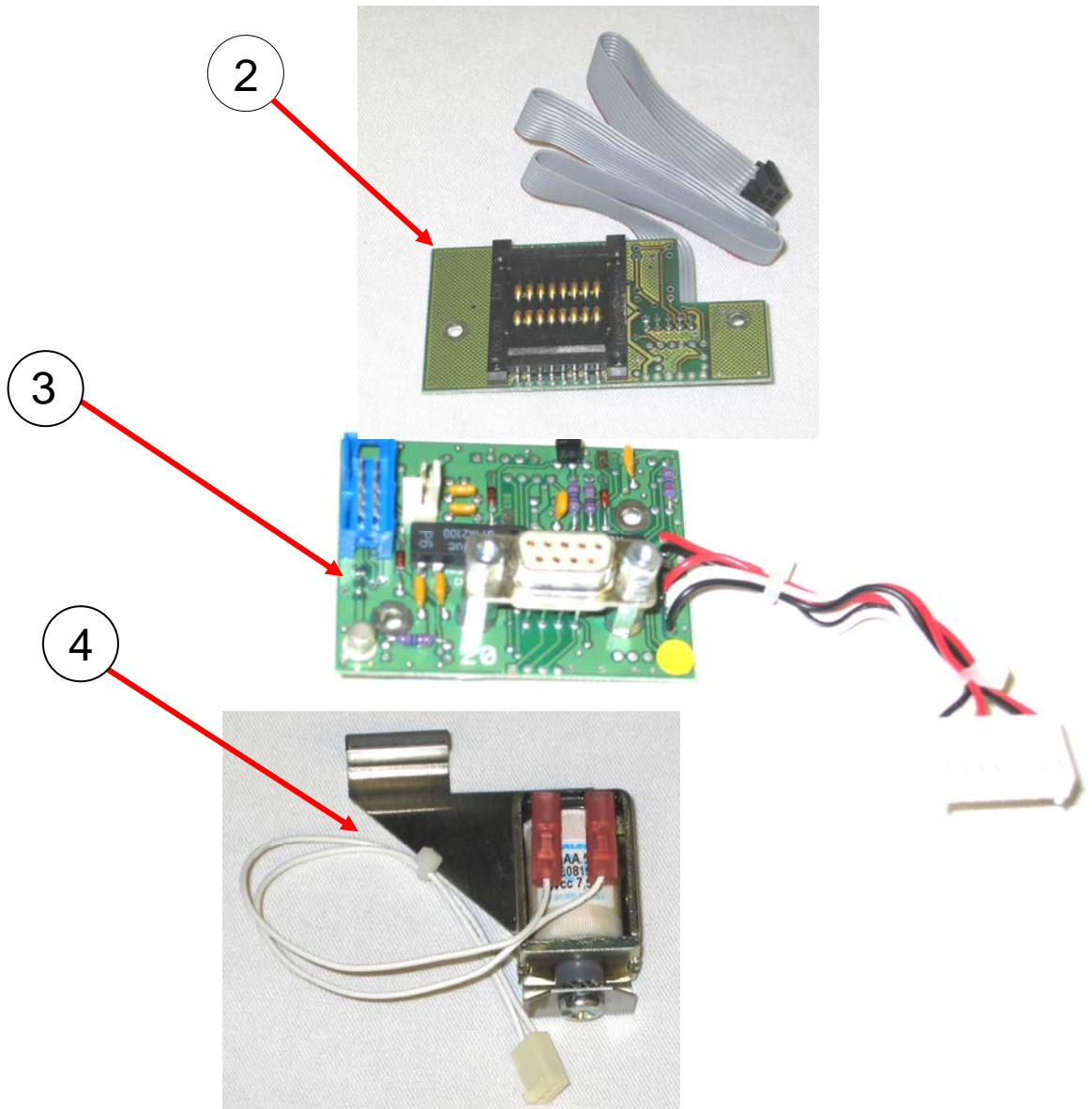

Item #	Kit Number	Description	Price
	105912-004	Smart Card Kit Complete (*)	248.00
2	105912-717	Smart Card w/Smart Header	45.00
3	105912-610	PCBA Smart Solenoid	97.00
4	105912-608	Smart Card Solenoid and Plunger Assembly	78.00

* Includes Spring Grip 105912-911

REAR PANEL VIEW



Kit Number	Description	Price
105912-515	AC RECEPTACLE	42.00

P310 AC POWER SWITCH



Kit Number	Description	Price
105912-516	AC POWER SWITCH 5/kit	33.00

REAR PANEL VIEW



Kit Number

Description

Price

105912-514	Communications Interface Assembly Kit PARALLEL CONNECTOR	25.00
-------------------	---	-------

REAR PANEL VIEW

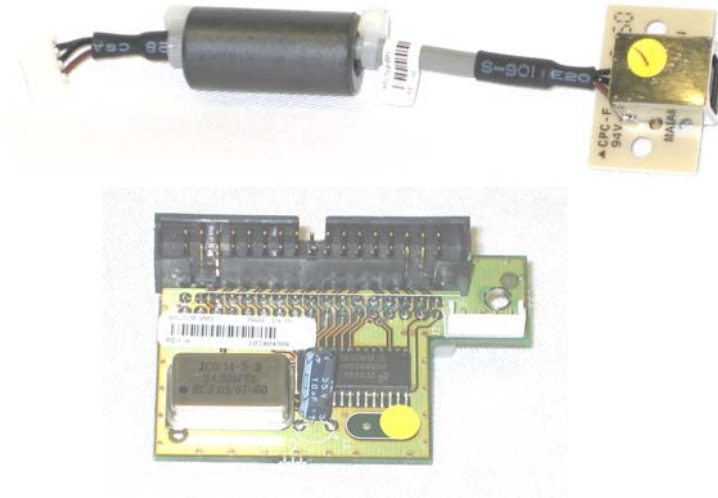

Kit Number	Description	Price
105912-583	USB Upgrade Kit ,P310i, CP	95.00
105912-202	Kit, USB Upgrade, P310C, CP	95.00

REAR PANEL VIEW



Kit Number	Description	Price
105912-779	Kit USB Socket ,P310i, CP	33.00
105912-512	Kit, USB Socket, P310C, CP	33.00

REAR PANEL VIEW



Kit Number	Description	Price
105912-034	MANUAL HOLDER	34.00

PRINT ENGINE – Covers

P310C/I Printer Models

P310 Enclosures

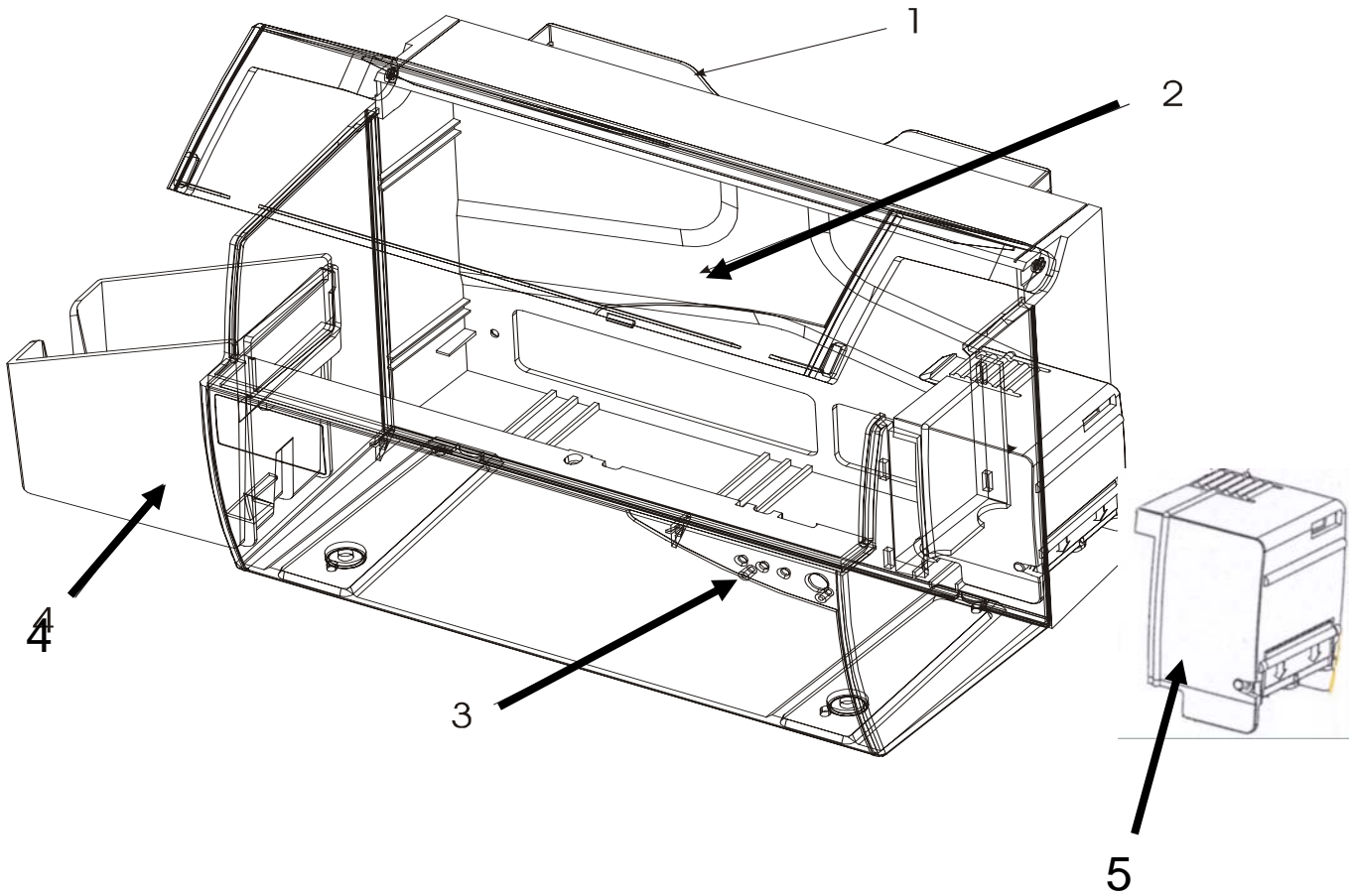

Item #	Part Number	Description	Price
--------	-------------	-------------	-------

1	105912-034	P310/P420/P520 Manual Holder	34.00
2	105912-035	P310 Enclosure Kit	375.00
3	105912-036	PCBA LED Switch Panel	113.00
4	105912-038	P310 Hopper Kit	53.00
5	105912-024	Cassette Feeder Kit	77.00